

STANDARD HORIZON

HX851

Floating Marine Transceiver with GPS

Owner's Manual



TABLE OF CONTENTS

QUICK REFERENCE GUIDE	4
RF EXPOSURE SAFETY STATEMENT	7
FCC AND CANADA RADIO LICENSE INFORMATION	8
MARITIME STATION LICENSE	8
MARINE RADIO CALL SIGN	8
CANADIAN SHIP STATION LICENSING	8
FCC / INDUSTRY CANADA INFORMATION	8
FCC NOTICE	9
1 GENERAL INFORMATION	10
1.1 INTRODUCTION	10
2 ACCESSORIES	11
2.1 PACKING LIST	11
2.2 OPTIONS	11
3 ABOUT THIS RADIO	12
3.1 ABOUT THE VHF MARINE BAND	12
3.2 EMERGENCY (CHANNEL 16 USE)	12
3.3 CALLING ANOTHER VESSEL (CHANNEL 16 OR 9)	13
3.4 OPERATING ON CHANNEL 13	14
3.5 OPERATING ON CHANNEL 67	14
4 GETTING STARTED	15
4.1 RADIO CARE	15
4.2 BATTERIES AND CHARGERS	15
4.3 CONNECTING A CHART PLOTTER TO THE CD-38	19
5 CONTROLS AND SWITCHES	20
6 BASIC OPERATION	24
6.1 PROHIBITED COMMUNICATIONS	24
6.2 INITIAL SETUP	24
6.3 RECEPTION	24
6.4 TRANSMISSION	25
6.5 DISPLAY MODE SETUP	26
6.6 USA, CANADA, AND INTERNATIONAL CHANNELS	27
6.7 SIMPLEX/DUPLEX CHANNEL USE	27
6.8 NOAA WEATHER CHANNELS	28
6.9 SCANNING	29
6.10 DUAL WATCH	31
6.11 PRESET CHANNELS (0 ~ 9): INSTANT ACCESS	32
6.12 STROBE LIGHT OPERATION	33
7 DIGITAL SELECTIVE CALLING	34
7.1 GENERAL	34
7.2 MARITIME MOBILE SERVICE IDENTITY (MMSI)	34
7.3 DSC DISTRESS ALERT	36
7.4 ALL SHIPS CALL	40
7.5 INDIVIDUAL CALL	42
7.6 CALL WAITING DIRECTORY	47
7.7 GROUP CALL	49
7.8 POSITION REQUEST	54
7.9 POSITION REPORT	59
7.10 GEOGRAPHIC CALL	62
7.11 DSC TRANSMISSION TEST	63

TABLE OF CONTENTS

8	RADIO SETUP	64
8.1	DISPLAY	64
8.2	DIMMER	65
8.3	CONTRAST	65
8.4	LAMP	66
8.5	PRIORITY CHANNEL	66
8.6	SCAN TYPE	67
8.7	SCAN MEMORY	67
8.8	SCAN RESUME	68
8.9	KEY BEEP	68
8.10	WEATHER ALERT	69
8.11	CHANNEL NAME	70
8.12	LED SETUP	71
9	DSC SETUP MENU	72
10	GPS SETUP	74
10.1	UNIT POWER	74
10.2	POWER SAVE MODE	74
10.3	COORDINATE SYSTEM	75
10.4	TIME OFFSET	76
10.5	TIME DISPLAY	77
10.6	TIME FORMAT	77
10.7	SOG UNIT	78
10.8	POS DATA PRIORITY	78
10.9	NMEA OUTPUT	79
10.10	ALTITUDE UNIT	79
11	COMPASS SETUP	80
12	WAYPOINTS	81
12.1	STORING WAYPOINTS	81
12.2	EDITING A WAYPOINT	82
12.3	DELETING A WAYPOINT	83
12.4	SAVING A DSC POSITION CALL AS A WAYPOINT	83
12.5	NAVIGATING TO A SAVED WAYPOINT	84
12.6	STOP NAVIGATING TO A WAYPOINT	84
12.7	WAYPOINT SETUP	85
13	MAINTENANCE	86
13.1	GENERAL	86
13.2	REPLACEMENT PARTS	86
13.3	FACTORY SERVICE	87
13.4	TROUBLESHOOTING CHART	87
14	CHANNEL ASSIGNMENTS	88
15	WARRANTY	94
16	INSTALLATION OF OPTION	97
16.1	FBA-38 ALKALINE BATTERY CASE	97
17	SPECIFICATIONS	98
17.1	GENERAL	98
17.2	TRANSMITTER	98
17.3	RECEIVER	99
17.4	GPS	99

QUICK REFERENCE GUIDE

[▲]/[▼] BUTTONS

- Selects the operating channel.
- Adjusts the audio volume level.
- Adjusts the squelch threshold level.
- Selects the item in the “DSC Call Menu” and “Setup Menu”.

TRANSMISSION SWITCH

Speak into the microphone in a normal voice level while pressing this switch.

[VOL(STROBE)] BUTTON

- Press this key first, then press the [▲] key to increase the audio level or press the [▼] key to reduce the audio level.
- Press and hold to turn on or off the strobe light.

[H/L (On)] BUTTON

- Press to toggle the transmit power between High (6W), M2 (5W), M1 (2.5W) and Low (1W).
- Press and hold to lock and unlock the keypad.

[POWER] BUTTON

Press and hold to toggle the radio on or off.

[DISTRESS] BUTTON

Note: for this button to operate a MMSI must be programmed.

Lift the red cover, press the Distress button once, then press and hold until the radio alarms.

[SQL] BUTTON

Press this key first, then press the [▲] key to squelch or press the [▼] key to un-squelch the radio.

[16/9] BUTTON

- Press to recall channel 16.
- Press and hold to recall channel 9.

MIC

When transmitting, position your mouth about 1/2 to 1 inch (1.2 ~ 2.5 cm) away from the small mic hole. Speak slowly and clearly into the microphone.

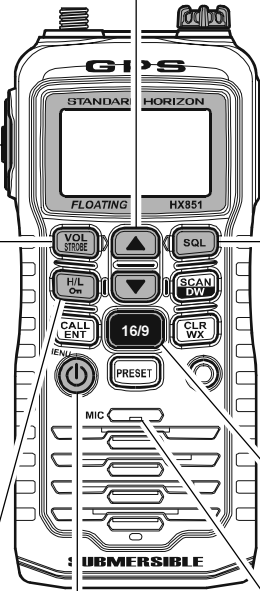

QUICK REFERENCE GUIDE

[CALL(ENT)/MENU] BUTTON

- Press to access the “DSC MENU”.
- Press and hold to access the Radio and DSC setup menus.
- When “DSC Call Menu” or “Setup Menu” are selected, pressing this key saves a selection.

[SCAN(DW)] BUTTON

- Press to start and stop the scanning of programmed channels.
- Press and hold to watch on CH16, CH70, and the current operating channel (Triple Watch).

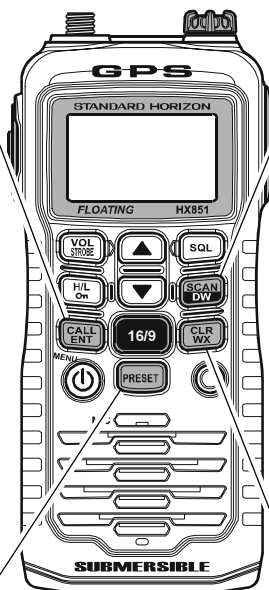

[PRESET] BUTTON

- Press to recall the “Preset” channel.
- Press and hold to save the current channel into the Preset Memory.

[CLR(WX)] BUTTON

- Press to cancel the menu selection.
- Press and hold to recall the last-used NOAA Weather Channel.

Congratulations on your purchase of the **HX851**! Whether this is your first portable marine VHF transceiver, or if you have other STANDARD HORIZON equipment, the STANDARD HORIZON organization is committed to ensuring your enjoyment of this high performance transceiver, which should provide you with many years of satisfying communications even in the harshest of environments. STANDARD HORIZON technical support personnel stands behind every product sold, and we invite you to contact us by phone 800/767-2450 or email marinetech@vxstdusa.com.

We appreciate your purchase of the **HX851**, and encourage you to read this manual thoroughly, so as to learn and fully understand the capabilities of the **HX851**.

NOTE

Water resistance of the transceiver is assured only when the battery pack is attached to the transceiver and **MIC/SP** cap is installed in the **MIC/SP** jack.

WARNING

This radio is capable of transmitting on Marine VHF.

The FCC allows the use of VHF Marine band on water areas only. However the FCC does not allow the use of the VHF Marine band when on land. If persons use the VHF Marine Band on land and interfere with others communicating, the FCC will be notified and search for the interference. Responsible parties found to be transmitting on the VHF Marine Band on land could be fined up to \$10,000 for the first offense.

RF EXPOSURE SAFETY STATEMENT

SAFETY INFORMATION

Your wireless handheld portable transceiver contains a low power transmitter. When the Push-to-Talk (PTT) button is pushed, the transceiver sends out radio frequency (RF) signals. In August 1996, the Federal Communications Commission adopted RF exposure guidelines with safety levels for hand-held wireless devices.

This device is authorized to operate at a duty factor not to exceed 50 % (this corresponds to 50% transmission time and 50 % reception time).

WARNING: To maintain compliance with the FCC's RF exposure guidelines, this transmitter and its antenna must maintain a separation distance of at least 1 inch (2.5 centimeters) from your face. Speak in a normal voice, with the antenna pointed up and away from the face at the required separation distance.

If you use a headset accessory for this radio, with the radio worn on your body, use only the Vertex Standard belt clip for this transceiver, and ensure that the antenna is at least 1 inch (2.5 centimeters) from your body when transmitting.

Use only the supplied antenna. Unauthorized antennas, modifications, or attachments could damage the transmitter, and may violate FCC regulations.

NOTE

This radio telephone complies with the requirements of RTCM Paper 56-95/SC101 Standards for digital selective calling (DSC) for Marine transceivers.

FCC AND CANADA RADIO LICENSE INFORMATION

Standard Horizon radios comply with the Federal Communication Commission (FCC) and Industry-Canada requirements that regulate the Maritime Radio Service.

MARITIME STATION LICENSE

An FCC ship station license is no longer required for any vessel traveling in U.S. waters which uses a VHF marine radio, RADAR or EPIRB, and which is not required to carry radio equipment. However, any vessel required to carry a marine radio on an international voyage, carrying a HF single side band radio-telephone or marine satellite terminal. FCC license forms, including applications for ship (605) and land station licenses can be downloaded via the Internet at www.fcc.gov/Forms/Form605/605.html. To obtain a form from the FCC, call (888) 225-5322.

MARINE RADIO CALL SIGN

Currently the FCC does not require recreational boaters to have a Ship Radio Station License. The USCG recommends the boats registration number and the state to be used.

CANADIAN SHIP STATION LICENSING

You may need a license when traveling in Canada. If you do need a license contact their nearest field office or regional office or write:

**Industry Canada
Radio Regulatory Branch
Attn: DOSP
300 Slater Street
Ottawa, Ontario
Canada, KIA 0C8**

FCC/INDUSTRY CANADA INFORMATION

The following data pertaining to the transceiver is necessary to fill out the license application.

FCC Type Accepted: Part 80
Output Power with FNB-V99LI: 1.0/2.5/5.0/6.0 W (Low/M1/M2/High)
Emission: 16K0G3E, 16K0G2B
Frequency Range: 156.025 to 163.275MHz
FCC Type Number: K6630313X30
Industry Canada Type Approval: 511B-30313X30

FCC NOTICE

Unauthorized changes or modifications to this equipment may void compliance with FCC Rules. Any change or modification must be approved in writing by STANDARD HORIZON, a Marine Division of VERTEX STANDARD.

NOTICE

This equipment has been tested and found to comply with the limits for a Class B digital device, pursuant to Part 15 of the FCC Rules. These limits are designed to provide reasonable protection against harmful interference in a residential installation. This equipment generates uses and can radiate radio frequency energy and, if not installed and used in accordance with the instructions, may cause harmful interference to radio communications. However, there is no guarantee that interference will not occur in a particular installation. If this equipment does cause harmful interference to radio or television reception, which can be determined by turning the equipment off and on, the user is encouraged to try to correct the interference by one or more of the following measures:

- Increase the separation between the equipment and receiver.
- Connect the equipment into an outlet on a circuit different from that to which the receiver is connected.
- Consult the dealer or an experienced marine electronics technician for help.

1 GENERAL INFORMATION

1.1 INTRODUCTION

The **HX851** is a Submersible Floating 6-Watt portable two way marine transceiver with a 12 channel internal GPS. The transceiver has all allocated USA, International, or Canadian channels. It has emergency channel 16 which can be immediately selected from any channel by pressing the **[16/9]** key. NOAA (National Oceanic and Atmospheric Administration) Weather channels can also be accessed immediately by press and holding the **[CLR(WX)]** key.

The **HX851** includes the following features: Memory Scanning, Priority Scanning, NOAA Weather Alert, Battery Saver, easy-to-read large LCD display, EEPROM memory back-up, Battery Life displayed on LCD, and a transmit Time-Out Timer (TOT).

The **HX851** transmitter provides a full 6 Watt of transmit power and is selectable to 5, 2.5, and 1 Watt to assist the user in ensuring maximum battery life.

The **HX851** has the capability of Digital selective Calling with Distress call including GPS position, All Ship Urgency and Safety, Individual, Group and Position Request and Position Report calls.

In addition, the **HX851** has navigation features which include Waypoint entering (store up to 200 waypoints), Navigation to a waypoint, Navigation to a DSC Position request, Luminescent Glow in the Dark gasket and a water enabled SOS strobe light.

2 ACCESSORIES

2.1 PACKING LIST

When the package containing the transceiver is first opened, please check it for the following contents:

- **HX851** Transceiver
- **CAT460** Antenna
- **FNB-V99LI** 7.4 V, 1150 mAh Li-ion Battery Pack
- **CD-38** Charger Cradle for **HX851**
- **NC-88B** 120VAC Wall Charger for **CD-38**
- **E-DC-19A** DC Cable with 12 V Cigarette Lighter Plug for **CD-38**
- Belt Clip
- Owner's Manual

2.2 OPTIONS

- ① **MH-73A4B** Speaker/Microphone
- ② **MH-57A4B** Mini Speaker/Microphone
- ③ **VC-24** VOX Headset
- ④ **VC-27** Earpiece/Microphone
- ⑤ **CN-3** Radio-to-Ship's-Antenna Adapter
- ⑥ **CD-38** Charger Cradle
- ⑦ **FNB-V99LI** 7.4 V, 1150 mAh Li-Ion Battery Pack
- ⑧ **FBA-38** Alkaline Battery Case
- ⑨ **E-DC-19A** DC Cable with 12 V Cigarette Lighter Plug
- ⑩ **NC-88B/C/U*** Wall Charger for the **FNB-V99LI**
- ⑪ **E-DC-6** DC Cable; plug and wire only

*: "B" suffix is for use with 120 VAC (Type-A plug), "C" suffix is for use with 230 VAC (Type-C plug), and "U" suffix is for use with 230 VAC (Type-BF plug).

Note: Before operating the **HX851** for the first time, it is recommended that the battery be charged. Please see section "4.2.4 USING THE CD-38 CHARGER CRADLE" for details.

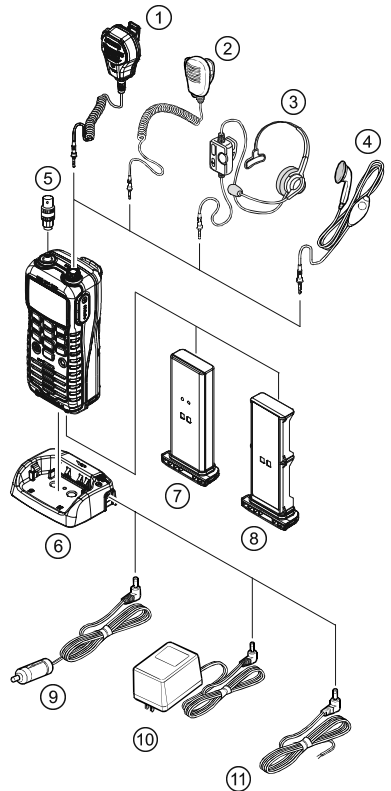

3 ABOUT THIS RADIO

3.1 ABOUT THE VHF MARINE BAND

WARNING

The radio frequencies used in the VHF marine band lie between 156 and 158 MHz with NOAA Weather stations available between 161 and 163 MHz. The marine VHF band provides communications over distances that are essentially “Line of sight” Actual transmission range depends much more on antenna type, gain and height than on the power output of the transmitter. The expected transmit distance a 25W Fixed Mount VHF radio can be greater than 15 miles, for a portable radio transmission the expected distance can be greater than 5 miles in “Line of sight”.

The user of a Marine VHF radio is subject to severe fines if the radio is used on land. The reasoning for this is you may be near an inland waterway, or propagation anomalies may cause your transmission to be heard in a waterway. If this occurs, depending upon the marine VHF channel on which you are transmitting, you could interfere with a search and rescue case, or contribute to a collision between passing ships. For VHF Marine channel assignments refer to page 88 section 14.

3.2 EMERGENCY (CHANNEL 16 USE)

Channel 16 is known as the Hail and Distress Channel. An emergency may be defined as a threat to life or property. In such instances, be sure the transceiver is on and set to CHANNEL 16. Then use the following procedure:

1. Press the **PTT** (Push-To-Talk) switch on the left side of the transceiver, and say “**Mayday, Mayday, Mayday**. This is _____, _____, _____” (your vessel’s name).
2. Then repeat once: “**Mayday, _____**” (your vessel’s name).
3. Now report your position in latitude/longitude, or by giving a true or magnetic bearing (state which) to a well-known landmark such as a navigation aid or geographic feature such as an island or harbor entry.
4. Explain the nature of your distress (sinking, collision, aground, fire, heart attack, life-threatening injury, etc.).
5. State the kind of assistance your desire (pumps, medical aid, etc.).
6. Report the number of persons aboard and condition of any injured.
7. Estimate the present seaworthiness and condition of your vessel.
8. Give your vessel’s description: length, design (power or sail), color and other distinguishing marks. The total transmission should not exceed one

minute.

9. End the message by saying “**OVER**”. Release the **PTT** switch and listen.
10. If there is no answer, repeat the above procedure. If there is still no response, try another channel.

3.3 CALLING ANOTHER VESSEL (CHANNEL 16 OR 9)

Channel 16 may be used for initial contact (hailing) with another vessel.

However, its most important use is for emergency messages. This channel must be monitored at all times except when actually using another channel.

It is monitored by the U.S. and Canadian Coast Guards and by other vessels. Use of channel 16 for hailing must be limited to initial contact only. Calling should not exceed 30 seconds, but may be repeated 3 times at 2-minute intervals. In areas of heavy radio traffic, congestion on channel 16 resulting from its use as a hailing channel can be reduced significantly in U.S. waters by using Channel 9 as the initial contact (hailing) channel for non-emergency communications. Here, also, calling time should not exceed 30 seconds but may be repeated 3 times at 2-minute intervals.

Prior to making contact with another vessel, refer to the channel charts in this manual, and select an appropriate channel for communications after initial contact. For example, Channels 68 and 69 of the U.S. VHF Charts are some of the channels available to non-commercial (recreational) boaters. Monitor your desired channel in advance to make sure you will not be interrupting other traffic, and then go back to either channel 16 or 9 for your initial contact.

When the hailing channel (16 or 9) is clear, state the name of the other vessel you wish to call and then “**this is**” followed by the name of your vessel and your Station License (Call Sign). When the other vessel returns your call, immediately request another channel by saying “**go to**”, the number of the other channel, and “**over**”. Then switch to the new channel. When the new channel is not busy, call the other vessel.

After a transmission, say “**over**”, and release the **PTT** (Push-To-Talk) switch. When all communication with the other vessel is completed, end the last transmission by stating your Call Sign and the word “**out**”. Note that it is not necessary to state your Call Sign with each transmission, only at the beginning and end of the contact.

Remember to return to Channel 16 when not using another channel. Some radios automatically monitor Channel 16 even when set to other channels or when scanning.

3.4 OPERATING ON CHANNEL 13

Channel 13 is used at docks, bridges and for maneuvering in port. Messages on this channel must concern navigation only, such as meeting and passing in restricted waters. In emergencies and when approaching blind river bends, High power is allowed. Pressing the [H/L(**On**)] key will change the power output from Low Power (1 Watt) to Medium-1 (2.5 Watts), Medium-2 (5 Watts), or High (6 Watts) power. When you change from this channel then return to it, Low Power will be automatically selected.

3.5 OPERATING ON CHANNEL 67

When channel 67 is used for navigational bridge-to-bridge traffic between ships, High, Medium-2, or Medium-1 power may be used temporarily (in the USA band) by pressing the [H/L(**On**)] key. When you select this channel again, the transceiver will revert to low power.

4 GETTING STARTED

4.1 RADIO CARE

CAUTION

Before following the instructions below, insure the speaker microphone jack, antenna and battery are in place and firmly tightened. Care must be taken if the radio was dropped and a close inspection may be needed to insure the radio case and gaskets are in adequate condition.

Clean the radio with fresh water after exposure to salt water by rinsing the radio under a sink faucet or by dunking the radio in a bucket of fresh water. After washing, use a soft cloth and thoroughly dry all parts of the radio. This is to keep the rubber switches and speaker grill clean and in top operating condition.

4.2 BATTERIES AND CHARGERS

If the radio has never been used, or its charge is depleted, it may be charged by connecting the **CD-38** Charger Cradle with the **NC-88B** battery charger, as shown in the illustration. If 12V DC power is available, the **E-DC-19A** DC Cable with 12 V Cigarette Lighter Plug or the optional **E-DC-6** DC Cable may be used for charging the battery. The **NC-88B**, **E-DC-19A** and **E-DC-6** will charge a completely discharged **FNB-V99LI** battery pack in about 8 hours.

The **FNB-V99LI** is a high performance Li-ion battery providing high capacity in a compact package.

CAUTION

To avoid risk of explosion and injury, **FNB-V99LI** battery pack should only be removed, charged or recharged in non-hazardous environments.

4.2.1 BATTERY SAFETY

Battery packs for your transceiver contain Li-ion batteries. This type of battery stores a charge powerful enough to be dangerous if misused or abused, especially when removed from the transceiver. Please observe the following precautions:

DO NOT SHORT BATTERY PACK TERMINALS: Shorting the terminals that power the transceiver can cause sparks, severe overheating, burns, and battery cell damage. If the short is of sufficient duration, it is possible to melt battery components. Do not place a loose battery pack on or near metal surfaces or objects such as paper clips, keys, tools, etc. When the battery pack is installed on the transceiver, the terminals that transfer current to the transceiver are not exposed. The terminals that are exposed on the battery pack

when it is mounted on the transceiver are charging terminals only and do not constitute a hazard.

DO NOT INCINERATE: Do not dispose of any battery in a fire or incinerator. The heat of fire may cause battery cells to explode and/or release dangerous gases.

Battery Maintenance

For safe and proper battery use, please observe the following:

- Battery packs should be charged only in non-hazardous environments;
- Use only STANDARD HORIZON-approved batteries;
- Use only a STANDARD HORIZON, (a Marine Division of VERTEX STANDARD) approved charger. The use of any other charger may cause permanent damage to the battery.
- Follow charging instructions provided with the chargers.
- Keep the battery contacts clean.

Battery Storage

Store the batteries in a cool place to maximize storage life. Since batteries are subject to self-discharge, avoid high storage temperatures that cause large self-discharge rates. After extended storage, a full recharge is recommended.

Battery Recycling

**DO NOT PLACE USED BATTERIES IN YOUR REGULAR TRASH!
LI-ION BATTERIES MUST BE COLLECTED, RECYCLED OR DISPOSED
OF IN AN ENVIRONMENTALLY SOUND MANNER.**

The incineration, land filling or mixing of Li-ion batteries with the municipal solid waste stream is PROHIBITED BY LAW in most areas.

Return batteries to an approved Li-ion battery recycler. This may be where you purchased the battery.

Contact your local waste management officials for other information regarding the environmentally sound collection, recycling and disposal of Li-ion batteries.

4.2.2 BATTERY INSTALLATION/REMOVAL

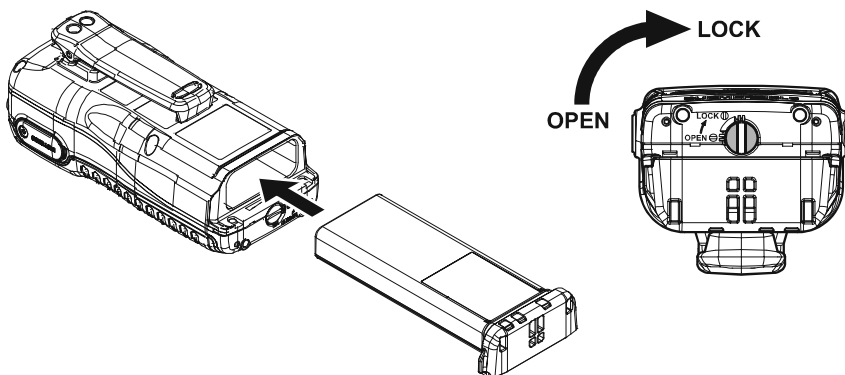

1. To install the battery pack, insert the battery pack into the bottom of the transceiver, then turn the Battery Pack Lock on the bottom of the transceiver to the “**LOCK**” position with a coin.
2. To remove the battery pack, turn the transceiver off, turn the Battery Pack Lock to the “**OPEN**” position with a coin, then slide out the battery from the transceiver.



NOTE

The battery lock must be set to “**LOCK**” position to ensure water integrity and from the battery coming loose.

4.2.3 BATTERY LIFE INFORMATION

When the battery charge is almost depleted, a “” icon will appear on the display. When the “” icon appears, it is recommended that you charge the battery soon.

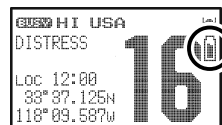



NOTE

When the **FBA-38** Alkaline Battery Case is used, the battery icon does not display correctly.

No Icon : Full Battery

 : Low Battery

 : Battery is very low

 : Prepare to charge the Battery

4.2.4 USING THE CD-38 CHARGER CRADLE

1. Turn the transceiver off.
2. Insert the DC plug from the **NC-88B** into the DC jack on the **CD-38** side panel, then plug the **NC-88B** into the AC line outlet.
3. Insert the **HX851** (with the battery pack) into the **CD-38**; the antenna should be at the left side when viewing the charger from the front.
4. If the **HX851** is inserted correctly, the **CD-38**'s LED indicator will glow red. A fully-discharged pack will be charged completely in approximately 8 hours.
5. When charging is completed, the red LED indicator will change to green.

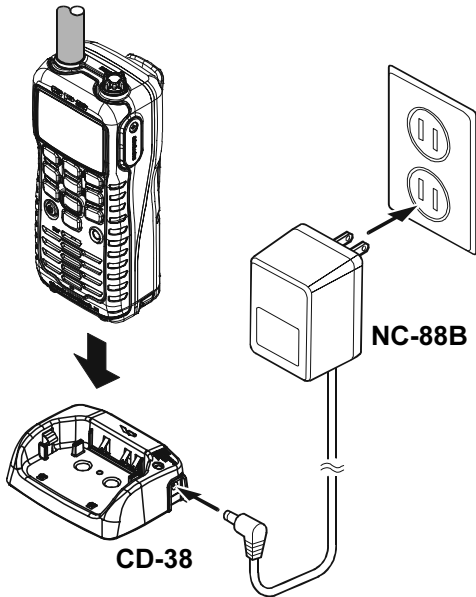

CAUTION

The **CD-38** is NOT designed to be waterproof. Charge the radio in a dry location.

NOTE

The **CD-38** is only designed for the charging of the **HX851**'s battery, and is not suitable for other purposes. The **CD-38** may contribute noise to TV and radio reception in the immediate vicinity, so we do not recommend its use adjacent to such device.

4.3 CONNECTING A CHART PLOTTER TO THE CD-38

The **CD-38** contains three wires that are used to input or output NMEA 0183 information when the **HX851** is inserted into the cradle.

The **HX851** outputs the following NMEA 0183 sentences:

GLL, GGA, GSA, GSV, RMC, DSC and DSE.

The **HX851** can receive and display information contained with the following NMEA 0183 sentences from an external GPS or GPS Chart Plotter:

GLL, GGA, and RMC.

Below are the wire colors and description of the wires supplied on the **CD-38**.

Wire Color/Description	Connection Examples
Brown- NMEA Input (+)	Connect to NMEA (+) output of GPS
Green - NMEA Input (-)	Connect to NMEA ground of GPS
Blue - NMEA Output (+)	Connect to NMEA (+) input of GPS

If you have further inquiries, please feel free to contact Product Support at:

Phone: (800) 767-2450

Email: marinetech@vxstdusa.com

To connect a chart plotter, connect the wires between the **CD-38** and the GPS and chart plotter. Insure that the wires are properly shielded from water.

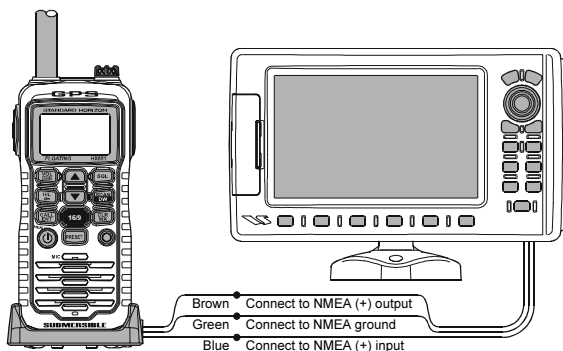

NOTE

When mounting the **HX851** inside of a cabin where GPS reception is limited, the NMEA input (brown) wire may be connected to a GPS Chart Plotter to input position into the **HX851**. To change the **HX851** from using the internal GPS antenna to an external GPS chart plotter with NMEA. Refer to section “10.8 POS DATA PRIORITY”.

NOTE

The Water Hazard LED must be turned off so the radio will output NMEA data to an external device (VHF Radio, PC, etc.). Refer to section “8.12 LED SETUP”.

5 CONTROLS AND SWITCHES

NOTE

This section defines each control of the transceiver. For detailed operating instructions, refer to section “**6 BASIC OPERATION**”. Refer to illustrations for the location of the following controls, switches, and connections.



NOTE

When transmitting, position your mouth about 1/2 to 1 inch (1.2 ~ 2.5 cm) away from the small mic hole. Speak slowly and clearly into the microphone.

① **ANT** Jack (Top Panel)

The supplied **CAT460** flexible antenna is attached here.

② **MIC/SP** Jack (Top Panel)

The jack accepts the optional **MH-73A4B** Speaker/Microphone, **MH-57A4B** Mini Speaker/Microphone, **VC-24** VOX Headset, or **VC-27** Earpiece/Microphone. When this jack is used, the internal speaker and microphone are disabled.

③ **PTT** (Push-To-Talk) Switch (Left side)

When pushed activates the transmitter.

④ **DISTRESS** Key (Right side)

Used to send a DSC Distress Call. To send the distress call, refer to section “7.3.1 TRANSMITTING A DSC DISTRESS ALERT”.

⑤ Keypad

[VOL(STROBE)] Key

Press this key to activate the volume adjusting mode. Press the [▼] or [▲] key to adjust the receiver audio volume level.

Secondary use:

Press and hold this key to toggle the light/strobe function on and off.

[SQL] Key

Press this key to activate the squelch adjusting mode. Press the [▼] or [▲] key to adjust the squelch threshold level.

Press and hold this key for 3 seconds to open the squelch, allowing you to monitor the operating channel. Release the key to resume normal (quiet) monitoring.

[▲(UP)] Key

This key is used to change the operating channel, receiver volume level, and squelch threshold level.

Press the key momentarily, the channel (or level) increases one step.

Holding the key, the channel (or level) increases continuously.

[▼(DOWN)] Key

This key is used to change the operating channel, receiver volume level, and squelch threshold level.

Press the key momentarily, the channel (or level) decreases one step.

Holding the key, the channel (or level) decreases continuously.

[H/L (🔊)] Key

Press this key to toggle the transmitter output power between “High” (6 Watts), “M2” (5 Watts), “M1” (2.5 Watts), and “Low” (1 Watt) power. This key does not function on the “Transmission Inhibited” and “Low power only” channels.

Secondary use:

Hold down this key to lock the keypad (except the **PTT**, **[VOL(STROBE)]**, **[SQL]**, **[POWER]**, and **[H/L (🔊)]** keys) so that they are not accidentally changed. The “🔊” icon will appear at the bottom right corner on the display, to indicate that the functions are locked. Hold down this key until the “🔊” icon disappears to unlock the radio.

[SCAN(DW)] Key

Press this key to start scanning of programmed channels.

Secondary use:

Press and hold this key to watch for a transmission on CH16, another selected channel, and CH70 until either signal is received (Triple Watch).

[CALL(ENT)MENU] KEY

Press this key to access the DSC Call Menu. The “Individual Call”, “Group Call”, “All Ships Call”, “Position Request”, “Position Report”, “DSC Log”, and “DSC Test” functions can be accessed from the DSC Call Menu.

Secondary use:

Press and hold this key to access the “Radio Setup”, “DSC Setup” or “GPS Setup” menu.

[16/9] Key

Pressing this key immediately recalls channel 16 from any channel location. Holding down this key recalls channel 9. Pressing this key again reverts to the previous selected working channel.

[CLR(WX)] Key

Press this key to cancel a menu selection and/or keypad entry.

Secondary use:

Immediately recalls the last-used NOAA Weather Channel from any channel location. Recalls the previously- selected working channel when the [CLR(WX)] key is pressed again.



Advanced use:

When the [16/9] key is held and the [CLR(WX)] key is pressed, the radio will change the marine band between the USA, International, and Canadian channels.

[PRESET] Key

Press this key to recall the “Preset” channel.

Secondary use:

Press and hold this key to memorize the current channel to the “Preset” memory channel. When pressed a “” icon will be shown on the LCD display indicating the channel has been saved to preset memory. To delete the channel from preset memory, select the channel and press and hold this key until “” is removed from the display.

[POWER(⏻)] KEY

Press and hold this key for two seconds to turn the radio on or off.

⑥ **TX/BUSY** Indicator

This indicator glows green when a signal is being received and red when transmitting.

When the Emergency feature is activated, this indicator blinks the internationally-recognized Morse Code “S.O.S” message.

⑦ Microphone

The internal microphone is located here.

NOTE

When transmitting, position your mouth about 1/2 to 1 inch (1.2 ~ 2.5 cm) away from the small mic hole. Speak slowly and clearly into the microphone.

⑧ Speaker

The internal speaker is located here.

⑨ NMEA Terminals (Bottom side)

Connect this NMEA input/output terminal to the GPS or Chart Plotter via the **CD-38** Charger Cradle. Keep these terminals clean.

⑩ Battery Pack Lock (Bottom side)

Turn the Battery Pack Lock to the “**OPEN**” position for battery removal.

BELT CLIP INSTALLATION / REMOVAL

INSTALLATION

Install the Belt Clip as shown below.

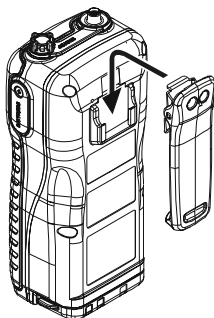

REMOVAL

The belt clip is designed to snap and lock into place. To remove the belt clip you may find it necessary to use a flat head screw driver to unlock the belt clip from the radio as shown in the image below.

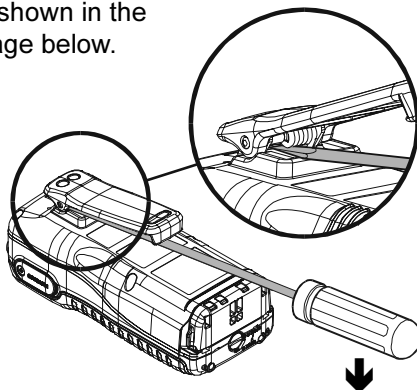

6 BASIC OPERATION

6.1 PROHIBITED COMMUNICATIONS

The FCC prohibits the following communications:

- False distress or emergency messages;
- Messages to “any boat” except in emergencies and radio tests;
- Messages to or from a vessel on land;
- Transmission while on land;
- Obscene, indecent, or profane language (potential fine of \$10,000).

6.2 INITIAL SETUP

1. Install the battery pack on the transceiver (see section “4.2.2 BATTERY INSTALLATION/REMOVAL”).
2. Install the antenna onto the transceiver; hold the bottom end of the antenna, then screw it onto the mating connector on the transceiver until it is snug. Do not over-tighten.

NOTE

Water resistance of the transceiver is assured only when the battery pack is attached to the transceiver and **MIC/SP** cap is installed in the **MIC/SP** jack.

6.3 RECEPTION

1. Press and hold the [**POWER**(☰)] key for two seconds to turn the transceiver on.
2. Press the [**SQL**] key to activate the squelch adjusting mode. Press the [▼] key until the “**SQL**” indicator will appear on the display, then press the [**SQL**] key again (or wait 3 seconds to exit from the squelch adjusting mode).
3. Press the [**VOL(STR)**] key to activate the audio volume adjusting mode. Press the [▼] / [▲] key until the noise or audio from the speaker is at a comfortable level, then press the [**VOL(STR)**] key again (or wait 3 seconds to exit from the volume adjusting mode).
4. Press the [**SQL**] key to activate the squelch adjusting mode again. Press the [▲] key until the random noise disappears, then press the [**SQL**] key again (or wait 3 seconds to exit from the squelch adjusting mode). This state is known as the “Squelch Threshold”.
5. Press the [▼] or [▲] key to select the desired channel. Refer to the channel chart on page 89 for available channels.
6. When a signal is received, adjust the volume (Press the [**VOL(STR)**] key, followed by the [▼]/[▲] key) to desired listening level. The “**SQL**” indicator will appear on the display indicating that the channel is being used.

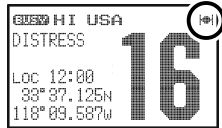

NOTE

When the **HX851** receives and computes a fix using the internal GPS, a “” icon will appear on the upper right corner of the display. Position and time will appear on the lower left corner of the display. When the transceiver fails to receive a fix, the radio will show the lower right display. In this case, you may be in a poor location for satellite reception, such as indoor use; try moving to a less obstructed position.



When the **HX851** is first turned on, it may take several minutes to compute a fix of your position. This is normal, as the **HX851** is downloading “almanac” information from the GPS satellites.

6.4 TRANSMISSION

1. Perform the “**6.3 RECEPTION**” discussion above.
2. Before transmitting, monitor the channel and make sure it is clear.
THIS IS AN FCC REQUIREMENT!
3. For communications over short distances, press the [**H/L**()] key until “**LO**” is displayed on the display. This indicates Low power (approximately 1 watt).
Note: Transmitting on 1 watt prolongs battery life. Low power (1 watt) should be selected whenever possible.
4. If using Low power is not effective, select M1 power (2.5 watts: “**M1**” icon appears), M2 power (5 watts: “**M2**” icon appears), or High power (6 watts: “**HI**” icon appears) by pressing the [**H/L**()] key.
5. When receiving a signal, wait until the incoming signal stops before transmitting. The transceiver cannot transmit and receive simultaneously.
6. Press the **PTT** (Push-To-Talk) switch to transmit. During transmission, the “” indicator will appear on the display and the **TX/BUSY** indicator will grow red.
7. Position your mouth about 1/2 to 1 inch (1.2 ~ 2.5 cm) away from the small mic hole. Speak slowly and clearly into the microphone.
8. When the transmission is finished, release the **PTT** switch.



6.4.1 TRANSMIT TIME - OUT TIMER (TOT)

While the **PTT** switch is held down, transmission time is limited to 5 minutes. This prevents prolonged (unintentional) transmissions. About 10 seconds before automatic transmitter shutdown, a warning beep sounds from the speaker. The transceiver automatically switches to the receiving mode, even if the **PTT** switch is held down. Before transmitting again, the **PTT** switch must first be released, then pressed again after 10 seconds. This Time-Out-Timer (TOT) prevents a continuous transmission that would result from an accidentally stuck **PTT** switch.

NOTE

The **PTT** switch will not operate for 10 seconds after the transceiver automatically switches to the receiving mode by the TOT feature.

6.5 DISPLAY MODE SETUP

The **HX851** display can be setup to show Radio information with GPS icon, GPS Position, GPS Position with SOG and COG, and GPS status with the procedure below.

1. Press and hold the **[CALL(ENT)MENU]** key until the “Setup Menu” appears.
2. Select “Radio Setup” with the **[▼] / [▲]** key, then press the **[CALL(ENT)MENU]** key.
3. Select “Display” with the **[▼] / [▲]** key, then press the **[CALL(ENT)MENU]** key.
4. Select the desired Display Type with the **[▼] / [▲]** key.

```
-Setup Menu-
>Radio Setup
  DSC Setup
  GPS Setup
Set>[ENT], Clear>[CLR]
```

```
-Radio Setup-
>Display
  Dimmer
  Contrast
  Lamp
Set>[ENT], Clear>[CLR]
```

```
-Display-
>Radio
  Position
  Navigation
  GPS Status
Set>[ENT], Clear>[CLR]
```

- Radio: Displays the “” icon only.
- Position: Displays your position and current time on the display.
- Navigation: Displays your position, COG (Course Over Ground: your current direction), and current time on the display.
- Compass: Displays your SOG (Speed Over Ground: your current speed), COG (Course Over Ground: your current direction) by the Rose Compass.
- Waypoint: Displays the distance and direction of the received vessel, and also the compass indicates the received vessel by dot (●).
- GPS Status: Displays apparent reception of GPS satellites, including the bar-graph of signal strengths.
5. Press the **[CALL(ENT)MENU]** key to store the selected setting, and return to radio operation mode.

NOTE

When the “GPS Status” mode is selected in step “4” above, the display will show the “GPS Status” page until a key is pressed.

You may customize the various functions of the **HX851** internal GPS unit for your operating requirements via the “GPS Setup” menu. Refer to section **“10 GPS SETUP”** for details.

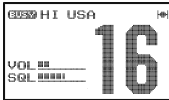

“RADIO” MODE



“POSITION” MODE

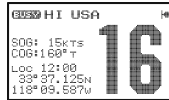

“NAVIGATION” MODE

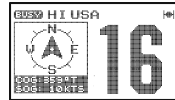

“COMPASS” MODE

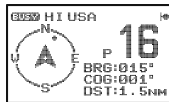

“WAYPOINT” MODE

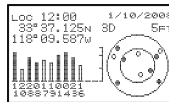

“GPS STATUS” MODE

6.6 USA, CANADIAN, AND INTERNATIONAL CHANNELS

1. To change from US to Canadian or International Marine Channels, hold down the [16/9] key and press the [CLR(WX)] key. The band will change from USA, to International, and to Canadian with each press.
2. “USA” appears on the LCD for the USA band, “CAN” appears for the Canadian band, and “INTL” appears for the International band.
3. Refer to the marine channel charts in section **“14 CHANNEL ASSIGNMENTS”** for allocated channels.



“USA” BAND



“CANADIAN” BAND

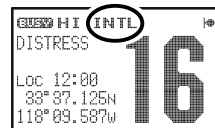

“INTERNATIONAL” BAND

6.7 SIMPLEX/DUPLEX CHANNEL USE

Refer to the VHF MARINE CHANNEL CHART (page 89) for instructions on use of simplex and duplex channels.

NOTE

All channels are factory-programmed in accordance with FCC (USA), Industry Canada and International regulations. The mode of operation cannot be altered from simplex to duplex or vice-versa. Simplex (ship to ship) or duplex (marine operator) mode is automatically activated, depending on the channel and whether the USA, International or Canadian operating band is selected.

6.8 NOAA WEATHER CHANNELS

1. To receive a NOAA (National Oceanic and Atmospheric Administration) weather broadcast, press and hold the **[CLR(WX)]** key. The transceiver changes to the weather channel mode, and recall the last used NOAA weather channel. This mode consists of a preset memory bank containing the NOAA weather channels.
2. Press the **[▼]** or **[▲]** key to change to other weather channels.
3. To exit from the weather channel mode, press and hold the **[CLR(WX)]** key. The transceiver will revert to the channel you were using prior to switching to the weather channel mode.



6.8.1 NOAA WEATHER ALERT

In the event of extreme weather disturbances such as storms and hurricanes, NOAA sends a “weather alert” consisting of a 1050 Hz tone, followed by weather reports on the weather channels.

When a “weather alert” is received on a weather channel, the transceiver emits a beep tone. Press the **[CLR(WX)]** key to stop the beep tone and listen to the weather reports.

NOTE

Four options for the Weather Alert feature are available, refer to section “**8.10 WEATHER ALERT**” for details.

6.8.2 NOAA WEATHER ALERT TESTING

In the event of a major storm or other appreciable weather condition requiring vessels at sea (or other bodies of water) to be notified, the NOAA (National Oceanographic and Atmospheric Administration) broadcasts a 1050 Hz tone which the **HX851** can detect and alert you of pending storm warnings (refer to section “**6.8.1 NOAA WEATHER ALERT**” for a discussion of how to use this feature). The 1050 Hz tone, when detected, will produce a loud beep in the speaker of the **HX851**, to signal that a Weather Alert Broadcast is being received.

In order to test this system, NOAA broadcasts the 1050 Hz tone every Wednesday sometime between 11 AM and 1 PM local time. You may use this opportunity to test your **HX851** periodically to confirm that the Weather Alert feature is working, or for training crew members on how to configure the **HX851** to receive the NOAA Weather Alerts.

6.9 SCANNING

The **HX851** allows the user to select the scan type from “Memory Scan” or “Priority Scan”. The “Memory Scan” scans the channels that were programmed into memory. The “Priority Scan” scans the channels programmed in memory with the user selected priority channel.

6.9.1 SELECTING THE SCAN TYPE

1. Press and hold the [CALL(ENT)MENU] key until the “Setup Menu” appears.
2. Select “Radio Setup” with the [▼] / [▲] key, then press the [CALL(ENT)MENU] key.
3. Select “SCAN Type” with the [▼] / [▲] key, then press the [CALL(ENT)MENU] key.
4. Select the desired Scan Type (“Memory Scan” or “Priority Scan”) with the [▼] / [▲] key.
5. Press the [CALL(ENT)MENU] key to store the selected setting.
6. Press the [16/9] key to exit the “Radio Setup” menu and return to radio operation mode.

```

-Setup Menu-
>Radio Setup
DSC Setup
GPS Setup
Compass Setup
Set>[ENT], Quit>[CLR]
    
```

```

-Radio Setup-
Contrast
Lamp
Priority CH
>SCAN Type
Set>[ENT], Quit>[CLR]
    
```

```

-SCAN TYPE-
Priority SCAN
Memory SCAN
Set>[ENT], Quit>[CLR]
    
```

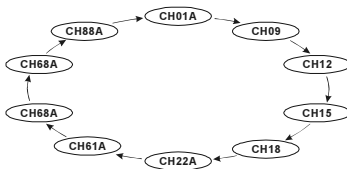

MEMORY SCAN

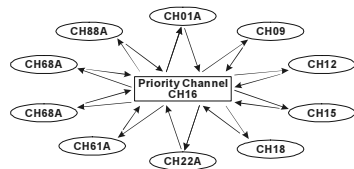

PRIORITY SCAN

6.9.2 PROGRAMMING SCAN MEMORY

1. Press and hold the [CALL(ENT)MENU] key until “Setup Menu” appears.
2. Press the [CALL(ENT)MENU] key, then select “SCAN Memory” in the “Radio Setup” menu with the [▼] / [▲] key.
3. Press the [CALL(ENT)MENU] key.
4. Press the [▼] / [▲] key to select a desired channel to be scanned, then press the [CALL(ENT)MENU] key. “MEM” icon appears on the display, which indicates the channel has been selected to the scan channel.
5. Repeat step 4 for all the desired channels to be scanned.

```

-Setup Menu-
>Radio Setup
DSC Setup
GPS Setup
Compass Setup
Set>[ENT]
    
```

```

-Radio Setup-
Lamp
Priority CH
SCAN Type
>SCAN Memory
Set>[ENT], Quit>[CLR]
    
```

```

-SCAN Memory-
>01A
03A
05A
06
Set>[ENT]
    
```

```

-SCAN Memory-
>01A MEM
03A
05A
06
Set>[ENT], Quit>[CLR]
    
```

- To DELETE a channel from the list, select the channel then press the [CALL(ENT)MENU] key. “MEM” icon disappears from the display.
- When you have completed your selection, press the [16/9] key or press the [CLR(WX)] several times to return to radio operation.

6.9.3 MEMORY SCANNING (M-SCAN)

- Press the [SQL] key to activate the squelch adjusting mode, then press the [▼] / [▲] key until the background noise disappears.
- Press the [SCAN(DW)] key, the “M-SCAN” icon appears on the display. Scanning will proceed from the lowest to the highest programmed channel number and Preset channel (described in the next chapter) and will stop on a channel when a transmission is received.
- The channel number will blink during reception.
- To stop scanning, press the [16/9] or [CLR(WX)] key.

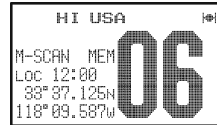

6.9.4 PRIORITY SCANNING (P-SCAN)

The “Priority Scan” allows the radio to “Memory Scan” while also keeping watch on a particularly important “Priority Channel”. In the default setting, Channel 16 is set as the priority channel. You may change the priority channel to the desired channel from Channel 16 by the “Radio Setup” menu, refer to section “8.5 PRIORITY CHANNEL”.

- Press the [SQL] key to activate the squelch adjusting mode, then press the [▼] / [▲] key until the background noise disappears.
- Press the [SCAN(DW)] key, the “P-SCAN” icon appears on the display. Scanning will proceed between the memorized channels and Preset channel (described in next chapter) and the priority channel. The priority channel will be scanned after each programmed channel.
- To stop scanning, press the [16/9] or [CLR(WX)] key.

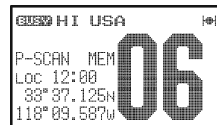

6.10 DUAL WATCH

The Dual Watch feature allows the radio watch the particularly important “Priority Channel” (determined section “6.9.4 PRIORITY SCANNING (P-SCAN)”) and one other channel.

1. Select the desired channel using the [▼] or [▲] key.
2. Press and hold the [SCAN(DW)] key until “TW-XX*” icon is shown on the display (*: Priority channel number).

Note: TW stands for Tri-Watch. it is shown to alert you the radio is actually watching the priority channel, the working channel and CH70, the DSC channel.

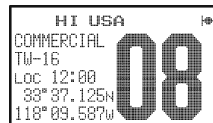



3. When a transmission is received on the “Priority Channel”, the radio will stay on the Priority channel until the incoming signal disappears.
4. The Dual Watch feature will resume when the incoming signal disappears at the end of the transmission.
5. Press the [SCAN(DW)] key or [CLR(WX)] key to stop the Dual Watch feature and return to normal operation.

6.11 PRESET CHANNELS (0 ~ 9): INSTANT ACCESS

10 Preset Channels can be programmed for instant access. Pressing the [PRESET] key activates the user assigned channel bank. If the [PRESET] key is pressed and no channels have been assigned, an alert beep will be emitted from the speaker.

6.11.1 PROGRAMMING

1. Press the [▼] / [▲] key to select a channel to be programmed.
2. Press and hold the [PRESET] key until the preset channel number “PRESET0” and a “” icon are displayed.
3. Release the [PRESET] key. The preset channel number “PRESET0” will disappear from the display after a few second.
4. Repeat steps 2 and 3 to program the desired channels into the PRESET memory.
5. To delete a Preset Channel: press the [PRESET] key numerous times until the channel the preset channel you want to delete is shown on the display. Press and hold the [PRESET] key until “” icon is removed from the display.

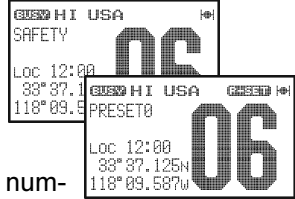

6.11.2 OPERATION

Pressing the [PRESET] key will toggle between Preset Channels “0” through “9” and the last selected “regular” channel. The Preset Channel number will disappear after five seconds.



6.12 STROBE LIGHT OPERATION

NOTE

Default setting is Continuous (like a flashlight).

1. Press and hold the [VOL(**STROBE**)] key to illuminate the **TX/BUSY** indicator with white continuously for useful as flashlight at night.
2. Press and hold the [VOL(**STROBE**)] key again to turn off the flashlight.

The continuous light maybe changed to 4 other selections including “**S.O.S. Strobe**”. When selected the LED will blink the internationally-recognized Morse Code “S.O.S.” message (·-·-·-·-·) at a rate of 5 words per minute. This can be very useful in summoning help from rescuers who may not be able to communicate with you via radio. To setup other Strobe light options, refer to “**8.12 LED SETUP**”.

7 DIGITAL SELECTIVE CALLING

7.1 GENERAL

WARNING

This radio is designed to generate a digital maritime distress and safety call to facilitate search and rescue. To be effective as a safety device, this equipment must be used only within communication range of a shore-based VHF marine channel 70 distress and safety watch system. The range of signal may vary but under normal conditions should be approximately 20 nautical miles.

Digital Selective Calling is a semi-automated method of establishing a radio call, it has been designated by the International Maritime Organization (IMO) as an international standard for establishing VHF, MF and HF radio calls. It has also been designated as part of the Global Maritime Distress and Safety System (GMDSS). It is planned that DSC will eventually replace aural watches on distress frequencies and will be used to announce routine and urgent maritime safety information broadcasts.

This system allows mariners to instantly send a distress call with GPS position (when connected to the transceiver) to the US Coast Guard and other vessels within range of the transmission. DSC will also allow mariners to initiate or receive Distress, Urgency, Safety, Routine, Position Request, and Position Send, and Group calls to or from another vessel equipped with a DSC transceiver.

7.2 MARITIME MOBILE SERVICE IDENTITY (MMSI)

7.2.1 WHAT IS AN MMSI?

An MMSI is a nine digit number used on Marine Transceivers capable of using Digital Selective Calling (DSC). This number is used like a telephone number to selectively call other vessels.

THIS NUMBER MUST BE PROGRAMMED INTO THE RADIO TO OPERATE THE HX851 DSC FUNCTIONS.

How can I obtain an MMSI assignment?

In the USA, visit the following websites to register:

<http://www.boatus.com/mmsi/> or

http://seatow.com/boating_safety/mmsi.asp

In the Canada, visit

<http://www.ic.gc.ca/epic/site/smt-gst.nsf/en/sf01032e.html> or

<http://www.usps.org/php/mmsi/rules.php>

7.2.2 USER MMSI PROGRAMMING

WARNING

A user MMSI can be inputted only once (as per governmental regulation). Therefore please be careful not to input the incorrect MMSI number. If you need to change the MMSI after it has been programmed, the radio will have to be returned to Factory Service. Refer to the section “**13.3 FACTORY SERVICE**”.

1. Press and hold down the [CALL(ENT)MENU] key until the “Setup Menu” appears.
2. Press the [▼] key to select “DSC Setup” menu.
3. Press the [CALL(ENT)MENU] key, then select “User MMSI” with the [▼] / [▲] key.
4. Press the [CALL(ENT)MENU] key.
5. Press the [▼] / [▲] key to select the first number of your MMSI, then press the [CALL(ENT)MENU] key to step to the next number.
6. Repeat step 5 to set your MMSI (nine digits).
7. If a mistake was made entering, repeatedly press the [H/L(ON)] key until the wrong number is selected, then press the [▼] / [▲] key to correct entry.
8. When finished programming the number, press and hold the [CALL(ENT)MENU] key. A confirmation message will appear on the display. Set your MMSI number again, then press and hold the [CALL(ENT)MENU] key.
9. Press the [CALL(ENT)MENU] key to store the MMSI number in memory.
10. Press the [CLR(MEM)] key twice to return to radio operation.

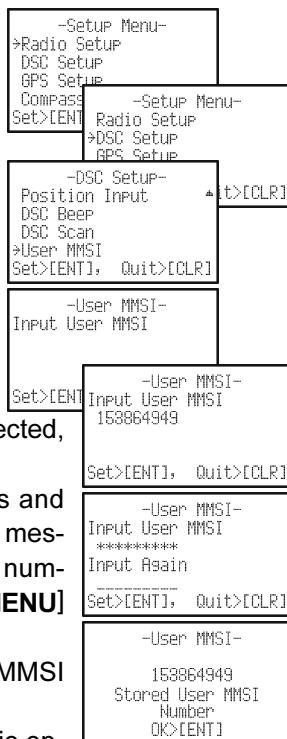

IMPORTANT NOTE

VHF handhelds used in the United States should use the MMSI assigned to the ship to which the handheld is primarily associated, even if another radio on that ship uses the same MMSI. If you plan to use the handheld on other boats, you might want a separate MMSI number so that you can update the registration according to which boat it is currently on.

7.3 DSC DISTRESS ALERT

The **HX851** is capable of transmitting and receiving DSC Distress messages to all DSC radios. The **HX851** will also send the Latitude and Longitude of the vessel when the internal GPS has acquired a satellite fix.

7.3.1 TRANSMITTING A DSC DISTRESS ALERT

NOTE

To be able to transmit a DSC Distress Alert an MMSI number must be programmed, refer to section “7.2.2 USER MMSI PROGRAMMING”. In order for your ship's location to be transmitted, the internal GPS unit must be activated, refer to “NOTE” on page 25.

1. Lift the red DISTRESS rubber cover on the right side of the transceiver and press the [DISTRESS] key. The “DISTRESS ALERT” menu will appear on the display.
2. Press and hold the [DISTRESS] key. The radio's display will count down (3-2-1), and afterwards the **HX851** will transmit the DSC Distress Alert on channel 70. The backlight of the display and keypad flashes while the radio's display counts down. When the Distress signal is being sent, the **TX/BUSY** indicator will grow red.
3. The transceiver “shadow-watches” for a transmission between Channel 16 and Channel 70 until an acknowledgment signal is received. The display will be shown in the illustration on the right.
4. If no acknowledgment is received, the distress call is repeated in 4 minute intervals until an acknowledgment is received.
5. When a DSC Distress acknowledgment is received, a distress alarm sounds and channel 16 is automatically selected. The display shows the MMSI of the ship responding to your distress.
RECEIVED ACK: acknowledgment signal is received.
RECEIVED RLY: relay signal is received from another vessel or coast station.
6. To cancel the DSC distress alarm signal from the speaker, press any key.

```
-DISTRESS ALERT-  
->Undesignated  
Press and hold 3 sec  
[DISTRESS] to transmit  
Nature of [▼],[▲]  
Cancel[CLR]
```

```
-DISTRESS ALERT-  
Undesignated  
Press and hold 1 sec  
[DISTRESS] to transmit  
Cancel[CLR]
```

```
-DISTRESS ALERT-  
Undesignated  
  
Transmitting
```

```
-DISTRESS ALERT-  
Wait for acknowledge  
  
Time:21:36  
Cancel[CLR]
```

Transmitting a DSC Distress Alert with Nature of Distress

The **HX851** is capable of transmitting a DSC Distress Alert with the following “Nature of Distress” categories:

Undesignated, Fire, Flooding, Collision, Grounding, Capsizing, Sinking, Adrift, Abandoning, Piracy, and MOB.

1. Lift the red DISTRESS rubber cover on the right side of the transceiver and press the **[DISTRESS]** key. The “DISTRESS ALERT” menu will appear on the display.

```
-DISTRESS ALERT-
>Undesignated
Press and hold 3 sec
[DISTRESS] to transmit
Nature of [▼],[▲]
Cancel[CLR]
```

2. Press the **[▼] / [▲]** key to select the desired “Nature of Distress” category.

```
-DISTRESS ALERT-
>Fire
Press and hold 3 sec
[DISTRESS] to transmit
Nature of [▼],[▲]
Cancel[CLR]
```

3. When the **HX851** internal GPS receiver has a fix, skip to step 4. When the **HX851** internal GPS receiver is either disabled or is not receiving a fix, you may enter in your coordinates and send them manually as detailed below.

- a. Press the **[CALL(ENT)MENU]** key twice. The display will be as shown in the illustration on the right.

```
-Position Input-
UTC: _:--:--
Lat: --:--.---_
Lon: --:--.---_
Set>[ENT], Quit>[CLR]
```

- b. Enter your local time by the 24-hour system on the UTC time with the **[▼] / [▲] / [CALL(ENT)MENU] / [H/L (On)]** key.

```
-Position Input-
UTC: 12:00
Lat: 00°07.125N
Lon: 118°09.587W
Set>[ENT], Quit>[CLR]
```

- c. Enter the Latitude/Longitude of your vessel location with the **[▼] / [▲] / [CALL(ENT)MENU] / [H/L (On)]** key.

- d. To store the data entered, press and hold the **[CALL(ENT)MENU]** key.

4. Press and hold the **[DISTRESS]** key. The radios display will count down (3-2-1), and afterwards the **HX851** will transmit the DSC Distress Alert on channel 70. The backlight of the display and keypad flashes while the radios display counts down. When the Distress signal is being sent, the **TX/BUSY** indicator will grow red.

```
-DISTRESS ALERT-
Fire
Press and hold 3 sec
[DISTRESS] to transmit
Cancel[CLR]
```

5. The transceiver “shadow-watches” for a transmission between Channel 16 and Channel 70 until an acknowledgment signal is received. The display will be shown in the illustration on the right.

```
-DISTRESS ALERT-
Fire
Transmitting
```

6. If no acknowledgment is received, the distress call is repeated in 4 minute intervals until an acknowledgment is received.

```
-DISTRESS ALERT-
Wait for acknowledge

Time:21:36
Cancel[CLR]
```

7. When a DSC Distress acknowledgment is received, a distress alarm sounds and channel 16 is automatically selected. The display shows the MMSI of the ship responding to your distress.

RECEIVED ACK: acknowledgment signal is received.

RECEIVED RLY: relay signal is received from another vessel or coast station.

8. To cancel the DSC distress alarm signal from the speaker, press any key.

7.3.2 CANCELING A DSC DISTRESS ALERT

If a DSC Distress Alert was sent by error the **HX851** allows you to send a message to other vessels to cancel the Distress Alert that was made in error.

Press the **[CLR(WX)]** key, then press the **[CALL(ENT)MENU]** key.

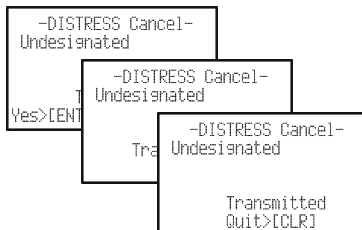

7.3.3 RECEIVING A DSC DISTRESS ALERT

1. When a DSC Distress Alert is received, an emergency alarm sounds.

Then channel 16 is automatically selected.

2. Press any key to stop the alarm.
3. Press the [▼] key several times to show information on the vessel in distress.
4. If you wish to display the position of the vessel in distress on the “WAYPOINT” screen, go to next step, otherwise press the **[CLR(WX)]** key to return to radio operation.
5. Press the **[CALL(ENT)MENU]** key to enter the “Waypoint Input” menu, then enter the desired waypoint name (up to 11 characters), described previously (select the letter/number by pressing the [▼] / [▲] key and move the cursor by pressing the **[CALL(ENT)MENU]** / **[H/L(On)]** key).
6. The ID is the MMSI from the vessel in distress.
7. When you are finished entering the waypoint name, press and hold the **[CALL(ENT)MENU]** key several times to show the “WAYPOINT” screen. The display indicates the distance and direction of the vessel in distress, and also the compass indicates the vessel in distress by dot (●).

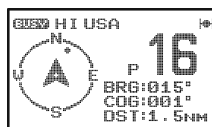
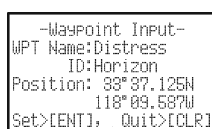
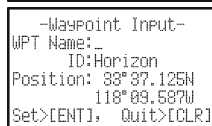
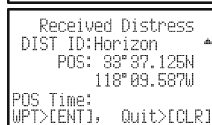
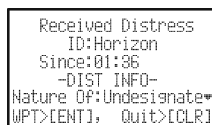

8. To stop navigating to the location of the position request call:
 - 1) Press and hold down the [**CALL(ENT)MENU**] key until “Setup Menu” appears.
 - 2) Press the [**▼**] / [**▲**] key to select “Radio Setup”.
 - 3) Press the [**CALL(ENT)MENU**] key, then select “Display” with the [**▼**] / [**▲**] key.
 - 4) Press the [**CALL(ENT)MENU**] key, and select “Radio”, “Position”, “Navigation” or “Compass” other than “Waypoint”, and press the [**CALL(ENT)MENU**] key.

NOTE

You must continue monitoring channel 16 as a coast station may require assistance in the rescue attempt.

7.4 ALL SHIPS CALL

The All Ships Call function allows contact to be established with other vessel stations without having their ID in the individual calling directory. Also, priority for the call can be designated as Urgency or Safety.

URGENCY Call: This type of call is used when a vessel may not truly be in distress, but have a potential problem that may lead to a distress situation. This call is the same as saying PAN PAN PAN on channel 16.

SAFETY Call: Used to transmit boating safety information to other vessels. This message usually contains information about an overdue boat, debris in the water, loss of a navigation aid or an important meteorological message. This call is the same as saying Securite, Securite, Securite.

7.4.1 SETTING UP THE ALL SHIPS RINGER

The **HX851** has the capability to turn off the All Ships ringer.

1. Press and hold the [CALL(ENT)MENU] key until "Setup Menu" appears.
2. Press the [▼] key to select "DSC Setup" menu.
3. Press the [CALL(ENT)MENU] key, then select "DSC Beep" with the [▼] / [▲] key.
4. Press the [CALL(ENT)MENU] key, then select "All Ships" with the [▼] / [▲] key.
5. Press the [CALL(ENT)MENU] key, then press the [▼] key to select "Off".
6. Press the [CALL(ENT)MENU] key to store the selected setting.
7. Press the [CLR(WX)] key twice to return to the "Setup Menu", then press the [CLR(WX)] key again to return to radio operation.

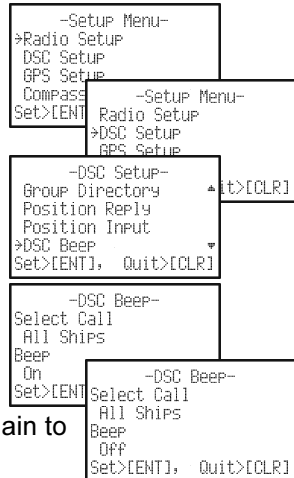

To return to enabling the ringer tone, repeat the above procedure, press the [▲] key to select "On" in step "5" above.

7.4.2 TRANSMITTING AN ALL SHIPS CALL

1. Press the **[CALL(ENT)MENU]** key. The “DSC Call Menu” will appear.
2. Press the **[▼]** key to select “All Ships”.
3. Press the **[CALL(ENT)MENU]** key. (To cancel, press the **[CLR(MEM)]** key.)
4. Press the **[▼] / [▲]** key to select the type of call (“Urgency” or “Safety”), then press the **[CALL(ENT)MENU]** key.
5. Press the **[CALL(ENT)MENU]** key again to transmit the selected type of All Ships DSC Call.
6. After the All Ships Call is transmitted, the transceiver will switch to Channel 16.
7. Listen to the channel to make sure it is not busy, then press the **PTT** switch and say “PAN PAN PAN” or “Securite, Securite, Securite” depending on the priority of the call. Then announce your call sign and announce the channel you wish to switch to for communications.

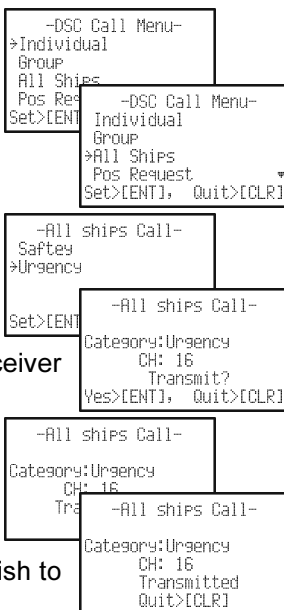

7.4.3 RECEIVING AN ALL SHIPS CALL

1. When an All Ships Call is received, an emergency alarm sounds. The radio will automatically change to Channel 16. The display shows the MMSI of the vessel transmitting the All Ships Call.
2. Press any key to stop the alarm.
3. Monitor channel 16 or traffic channel until the All Ship Call voice communication is completed.

7.5 INDIVIDUAL CALL

This feature allows the **HX851** to contact another vessel with a DSC VHF radio and automatically switch the receiving radio to a desired communications channel. This feature is similar to calling a vessel on Channel 16 and requesting to go to another channel (switching to the channel is private between the two stations).

7.5.1 SETTING UP THE INDIVIDUAL / POSITION CALL DIRECTORY

The **HX851** has a DSC directory that allows you to store a vessel or person's name and the MMSI number associated with vessels you wish to transmit Individual calls, Position Requests and Position Send transmissions. The **HX851** can memorize up to 24 stations.

To transmit an Individual call you must program this directory with information of the persons you wish to call, similar to a cellular phones telephone directory.

1. Press and hold the [CALL(ENT)MENU] key until "Setup Menu" appears.
2. Press the [▼] key to select "DSC Setup" menu.
3. Press the [CALL(ENT)MENU] key, then select "Individual Directory" with the [▼] / [▲] key.
4. Press the [CALL(ENT)MENU] key.
5. Select "Add" with the [▼] / [▲] key, then press the [CALL(ENT)MENU] key.
6. Press the [▼] / [▲] key to select the first letter of the name of the vessel or person you want to reference in the directory.
7. Press the [CALL(ENT)MENU] key to store the first letter in the name and step to the next letter to the right.
8. Repeat step 6 and 7 until the name is complete. The name can consist of up to eleven characters, if you do not use all eleven characters press the [CALL(ENT)MENU] key to move to the next space. This method can also be used to enter a blank space in the name. If a mistake was made entering in the name repeatedly press the [H/L(On)] key until the wrong character is selected, then press the [▼] / [▲] key to correct the entry.
9. After the eleventh letter or space has been entered, press and hold the [CALL(ENT)MENU] key to advance to the MMSI (Maritime Mobile Service Identity Number) number entry.
10. Press the [▼] / [▲] key to scroll through numbers, 0-9. To enter the desired number and move one space to the right press the [CALL(ENT)MENU]

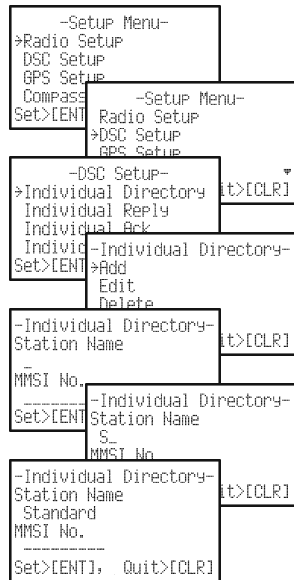

key. Repeat this procedure until all nine space of the MMSI number are entered.

11. If a mistake was made entering in the MMSI number repeat pressing the [H/L(On)] key until the wrong number is selected, then press the [▼] / [▲] key to correct the entry.
12. To store the data entered, press and hold the [CALL(ENT)MENU] key.
13. To enter another individual address, repeat steps 5 through 12.
14. Press the [CLR(WX)] key twice to return to the "Setup Menu", then press the [CLR(WX)] key again to return to radio operation.

```
-Individual Directory-  
Station Name  
Standard  
MMSI No.  
1-----  
Set>[ENT], Quit>[CLR]
```

```
-Individual Directory-  
Station Name  
Standard  
MMSI No.  
123456789  
Set>[ENT], Quit>[CLR]
```

7.5.2 SETTING UP INDIVIDUAL REPLY

Allows setting up the radio to automatically (default setting) or manually respond to a DSC Individual Call requesting you to switch to a working channel for voice communications. When "Manual" is selected the MMSI of the calling vessel is shown allowing you to see who is calling. This function is similar to caller id on a cellular phone.

1. Press and hold the [CALL(ENT)MENU] key until "Setup Menu" appears.
2. Press the [▼] key to select "DSC Setup" menu.
3. Press the [CALL(ENT)MENU] key, then select "Individual Reply" with the [▼] / [▲] key.
4. Press the [CALL(ENT)MENU] key.
5. Press the [▼] / [▲] key to select "Automatic" or "Manual".
6. Press the [CALL(ENT)MENU] key to store the selected setting.
7. Press the [CLR(WX)] key twice to return to radio operation.

```
-Setup Menu-  
->Radio Setup  
DSC Setup  
GPS Setup  
Compass Setup  
Set>[ENT], Quit>[CLR]
```

```
-Setup Menu-  
Radio Setup  
->DSC Setup  
GPS Setup  
Compass Setup  
Set>[ENT], Quit>[CLR]
```

```
-DSC Setup-  
Individual Directory  
->Individual Reply  
Individual Ack  
Individual Ringer  
Set>[ENT], Quit>[CLR]
```

```
-Individual Reply-  
->Automatic  
Manual  
Set>[ENT], Quit>[CLR]
```

7.5.3 SETTING UP INDIVIDUAL CALL RINGER

When an Individual Call or Group Call is received the radio will produce a ringing tone for 2 minutes. This selection allows the Individual Call ringer time to be changed.

1. Press and hold the [CALL(ENT)MENU] key until "Setup Menu" appears.
2. Press the [▼] key to select "DSC Setup" menu.
3. Press the [CALL(ENT)MENU] key, then select "Individual Ringer" with the [▼] / [▲] key.
4. Press the [CALL(ENT)MENU] key.
5. Press the [▼] / [▲] key to select ringing time of a Individual Call.
6. Press the [CALL(ENT)MENU] key to store the selected setting.
7. Press the [CLR(WX)] key twice to return to radio operation.

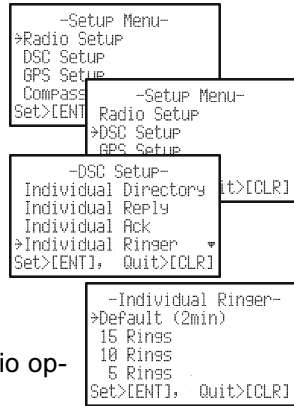

The HX851 has the capability to turn off the Individual Call ringer.

1. Press and hold the [CALL(ENT)MENU] key until "Setup Menu" appears.
2. Press the [▼] key to select "DSC Setup" menu.
3. Press the [CALL(ENT)MENU] key, then select "DSC Beep" with the [▼] / [▲] key.
4. Press the [CALL(ENT)MENU] key.
5. Press the [▼] / [▲] key to select "Individual", then press the [CALL(ENT)MENU] key.
6. Press the [▼] key to select "Off".
7. Press the [CLR(MEM)] key twice to return to the "Setup Menu", then press the [CLR(WX)] key again to return to radio operation.

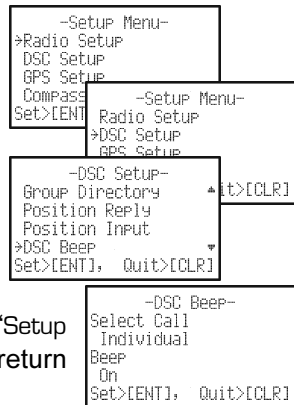

To enable the ringer tone, repeat the above procedure, press the [▲] key to select "On" in step "6" above.

7.5.4 TRANSMITTING AN INDIVIDUAL CALL

This feature allows the user to contact another vessel with a DSC radio. This feature is similar to calling a vessel on Channel 16 and requesting to go to another channel.

Pre-Programmable Calling

1. Press the [CALL(ENT)MENU] key. The “DSC Call Menu” will appear.
2. Press the [▼] / [▲] key to select “Individual”. (To cancel, press the [CLR(WX)] key.)
3. Press the [CALL(ENT)MENU] key. The transceiver will beep, and the “Individual Directory” will appear.
4. Press the [▼] / [▲] key to select the “Individual” you want to contact.
5. Press the [CALL(ENT)MENU] key, then press the [▼] / [▲] key to select the operating channel you want to communicate on and press the [CALL(ENT)MENU] key.
6. Press the [CALL(ENT)MENU] key again to transmit the Individual DSC signal.
7. When an Individual Call acknowledgment is received, the established channel is automatically changed to the channel which is selected on step 5 above and a ringing tone sounds.
8. Press the [CLR(WX)] key to listen to the channel to make sure it is not busy, then key the microphone and call the other vessel you desire to communicate with.

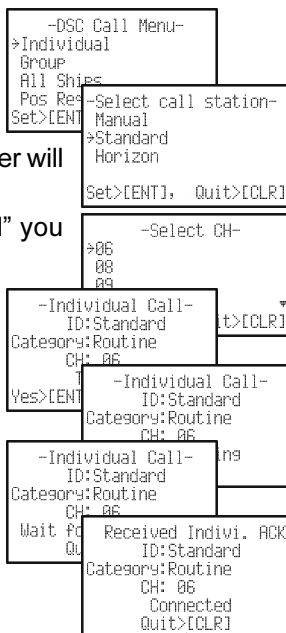

Manual Calling

You may enter an MMSI number manually to contact without storing it in the Individual Directory.

1. Press the [CALL(ENT)MENU] key. The “DSC Call Menu” will appear.
2. Press the [▼] / [▲] key to select “Individual”. (To cancel, press the [CLR(WX)] key.)
3. Press the [CALL(ENT)MENU] key. The transceiver will beep, and the “Individual Directory” will appear.
4. Press the [▼] / [▲] key to select “Manual”, then press the [CALL(ENT)MENU] key.
5. Press the [▼] / [▲] key to scroll through numbers, 0-9. To enter the desired number and move one space to

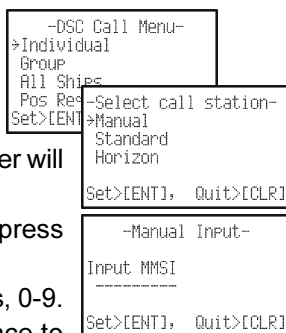

the right, press the **[CALL(ENT)MENU]** key. Repeat this procedure until all nine spaces of the MMSI number which you want to contact are entered.

```
-Manual Input-
Input MMSI
234567891
Set>[ENT], Quit>[CLR]
```

6. If a mistake was made entering in the MMSI number repeatedly press the **[H/L (On)]** key until the wrong number is selected, then press the **[▼] / [▲]** key to correct the entry.

```
-Select CH-
>06
08
09
10
Set>[ENT], Quit>[CLR]
```

7. When finished entering the MMSI number, press and hold the **[CALL(ENT)MENU]** key. The transceiver will beep, and the “Select Intership CH” menu will appear

```
-Select CH-
72
73
77
>Manual
Set>[ENT], Quit>[CLR]
```

8. Press the **[▼] / [▲]** key to select “Manual”, then press the **[CALL(ENT)MENU]** key.

```
- Manual Select CH-
68
```

9. Press the **[▼] / [▲]** key to select the operating channel you want to communicate on and press the **[CALL(ENT)MENU]** key.

10. Press the **[CALL(ENT)MENU]** key again to transmit the Individual DSC signal.

```
-Individual Call-
ID:234567891
Category:Routine
CH: 68
```

11. When an Individual Call acknowledgment is received, the established channel is automatically changed to the channel which is selected on step 5 above and a ringing tone sounds.

```
-Individual Call-
ID:234567891
Category:Routine
CH: 68
Yes>[ENT]
```

12. Press the **[CLR(WX)]** key to listen to the channel to make sure it is not busy, then key the microphone and call the other vessel you desire to communicate with.

```
-Individual Call-
ID:234567891
Category:Routine
CH: 68
Tr
Qu
```

```
Received Indivi. ACK
ID:234567891
Category:Routine
CH: 68
Connected
Quit>[CLR]
```

7.5.5 RECEIVING AN INDIVIDUAL CALL

When receiving an Individual Call, an acknowledgment transmission is sent back to the calling station to switch to a communication channel. The **HX851** default setting is Automatic, but has a manual menu selection that allows you to see the vessel calling before sending an reply. This selection is useful if you want to see who is calling and requesting you to switch to a channel for communications, similar to caller id on a cellular phone.

1. When an Individual Call is received, an Individual Call ringing alarm sounds.

The radio automatically (automatic mode selected) switches to the requested channel. The display shows the MMSI of the vessel calling.

```
Received Individual
ID:Standard
Category:Routine
CH: 06
Connected
Quit>[CLR]
```

2. Press any key to stop the alarm.

3. Press the **PTT** switch and talk to the calling ship.

7.6 CALL WAITING DIRECTORY

The **HX851** logs received Distress Calls and Individual Calls into the Call Waiting Directory for review at a later time. The DSC Call Waiting feature is similar to an answer machine where calls are recorded for review. When a call is logged while the radio is set on the DSC Standby function or when a DSC call is not replied to a “” icon will appear on the display. The **HX851** can memorize up to the latest 15 Distress, and up to the latest 32 Individual Calls.

7.6.1 ENABLING THE CALL WAITING FEATURE

Follow the steps below to enable or disable the Call Waiting feature.

1. Press and hold the [CALL(ENT)MENU] key until “Setup Menu” appears.
2. Press the [▼] key to select “DSC Setup” menu.
3. Press the [CALL(ENT)MENU] key, then select “Individual Ack” with the [▼] / [▲] key to select.
4. Press the [CALL(ENT)MENU] key.
5. Press the [▼] / [▲] key to select “Able to comply” or “Unable”.
6. Press the [CALL(ENT)MENU] key to store the selected setting.
7. Press the [CLR(MEM)] key twice to return to the “Setup Menu”, then press the [CLR(MEM)] key again to return to radio operation.

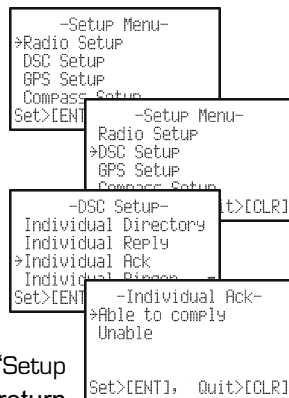

7.6.2 REVIEWING RECEIVED CALLS LOGGED INTO THE CALL WAITING DIRECTORY

1. Press the [CALL(ENT)MENU] key. The “DSC Call Menu” will appear.
2. Press the [▼] / [▲] key to select “DSC Log” menu.
3. Press the [CALL(ENT)MENU] key, then press the [▼] / [▲] key to select the category (“Distress Alert LOG” or “DSC Call LOG”) you want to review and/or call back.
4. Press the [CALL(ENT)MENU] key, then press the [▼] / [▲] key to select the station (name or MMSI number) you want to review and/or call back.
5. Press the [CALL(ENT)MENU] key, to review details for the selected station.
6. If you want to RELAY the DSC distress call to specific ship, press the [CALL(ENT)MENU] key, two times to show the “MANUAL” input display. Other-

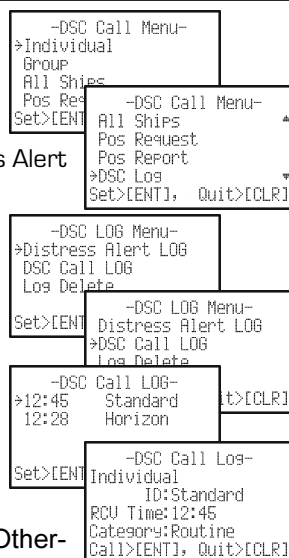

wise, press the [CLR(WX)] key numerous time to exit.

7. Use the [▼] / [▲] keys to enter the first number of the MMSI, then press the [CALL(ENT)MENU] key.
8. Repeat step 8 until all numbers are selected then press and [CALL(ENT)MENU] key.
9. Press and hold the [CALL(ENT)MENU] key to relay the Distress call to the vessel or press the [CLR(WX)] to exit.

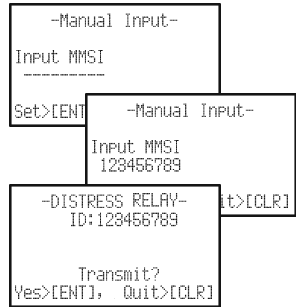

NOTE

When there is an unread received call, the category (“Distress Alert LOG” or “DSC Call LOG”) notation will blink.

7.6.3 DELETING THE DSC LOG

1. Press the [CALL(ENT)MENU] key. The “DSC Call Menu” will appear.
2. Press the [▼] / [▲] key to select “DSC Log” menu.
3. Press the [CALL(ENT)MENU] key, then press the [▼] / [▲] key to select “Log Delete”.
4. Press the [CALL(ENT)MENU] key, then press the [▼] / [▲] key to select the category (“Distress Alert LOG” or “DSC Call LOG”) to be deleted.
5. Press the [CALL(ENT)MENU] key, then press the [▼] / [▲] key to select the station (name or MMIS number) to be deleted.
6. Press and hold the [CALL(ENT)MENU] key until the station (name or MMSI number) is removed from the display.
7. Press the [16/9] key to return to radio operation.

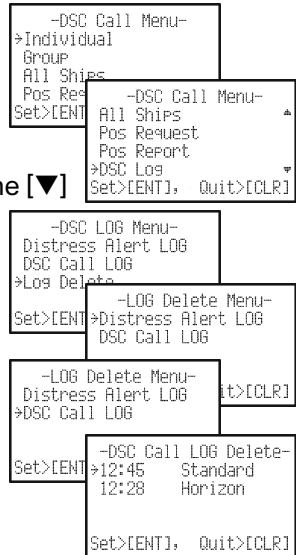

7.7 GROUP CALL

This feature allows the user to contact a group of specific vessels (example members of a yacht club) using DSC radios with Group call function to automatically switch to a desired channel for voice communications. This function is very useful for yacht clubs and vessels traveling together that want to collectively make announcements on a predetermined channel. The **HX851** can memorize up to 8 group address.

7.7.1 SETUP A GROUP CALL

For this function to operate the same Group MMSI must be programmed into all the DSC VHF radios within the group of vessels that will be using this feature. To understand about Group MMSI programming, first a Ship MMSI has to be understood.

Ship MMSI: The first three digits called a MID (Mobile Identity Group) of a Ship MMSI denote the country the ship registered for a MMSI. The last 6 digits are specific to the Ships ID.

Ship MMSI Example: If your MMSI is “366123456”, “366” is MID which denote the country and “123456” is Ships ID for you.

Group MMSI:

- ❑ Group MMSI numbers are not assigned by the FCC or other organizations licensed to assign ship MMSI numbers.
 - ❑ The first digit of a Group MMSI is always set to “0” by International rules. All Standard Horizon radios are preset so when programming a Group MMSI the first digit is set to “0”.
 - ❑ The USCG recommends programming the MID of a ships MMSI into the Second, Third and Fourth digits of the Group MMSI as it denotes the area the ship is located in.
 - ❑ The last 5 digits are decided upon by persons in the Group. This is an important step as all radios in the Group must contain the same Group MMSI so they can be contacted by each other. There is a chance that another group of vessels may program in the same Group MMSI. If this happens, simply change one or more of the last 5 digits of the Group MMSI.
1. Press and hold the [CALL(ENT)MENU] key until “Setup Menu” appears.
 2. Press the [▼] key to select “DSC Setup” menu.
 3. Press the [CALL(ENT)MENU] key, then select “Group Directory” with the [▼] / [▲] key.
 4. Press the [CALL(ENT)MENU] key.
 5. Select “Add” with the [▼] / [▲] key, then press the [CALL(ENT)MENU] key.

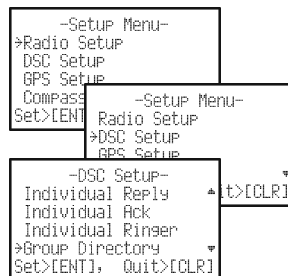

6. Press the [▼] / [▲] key to scroll through the first letter of the name of the group you want to reference in the directory.
7. Press the [CALL(ENT)MENU] key to store the first letter in the name.
8. Repeat step 6 and 7 until the name is complete. The name can consist of up to eleven characters, if you do not use all eleven characters press the [CALL(ENT)MENU] key to move to the next space. This method can also be used to enter a blank space in the name. If a mistake was made entering in the name repeatedly press the [H/L(On)] key until the wrong character is selected, then press the [▼] / [▲] key to correct the entry.
9. After the eleventh letter or space has been entered, press and hold the [CALL(ENT)MENU] key to advance to the GROUP MMSI (Maritime Mobile Service Identity Number) number entry.
10. Press the [▼] / [▲] key to scroll through numbers, 0-9. To enter the desired number and move one space to the right press the [CALL(ENT)MENU] key. Repeat this procedure until all nine space of the MMSI number are entered.
11. If a mistake was made entering in the MMSI number repeatedly press the [H/L(On)] key until the wrong number is selected, then press the [▼] / [▲] key to correct the entry.
12. To store the data entered, press and hold the [CALL(ENT)MENU] key.
13. To enter another Group Address, repeat steps 5 through 12.
14. Press the [CLR(WX)] key twice to return to the "Setup Menu", then press the [CLR(WX)] key again to return to radio operation.

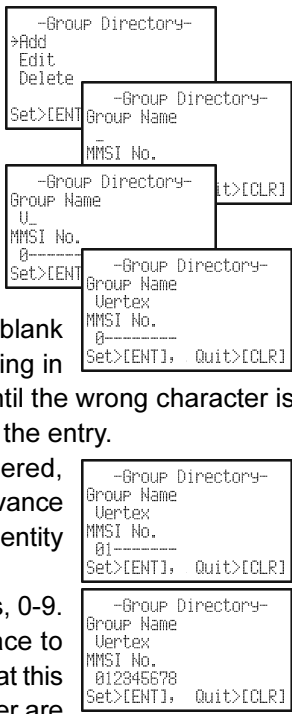

7.7.2 SETTING UP THE GROUP CALL RINGER

The HX851 has the capability to turn off the Group Call ringer.

1. Press and hold the [CALL(ENT)MENU] key until "Setup Menu" appears.
2. Press the [▼] key to select "DSC Setup" menu.
3. Press the [CALL(ENT)MENU] key, then select "DSC Beep" with the [▼] / [▲] key.
4. Press the [CALL(ENT)MENU] key.
5. Press the [▼] / [▲] key to select "Group", then press the [CALL(ENT)MENU] key.

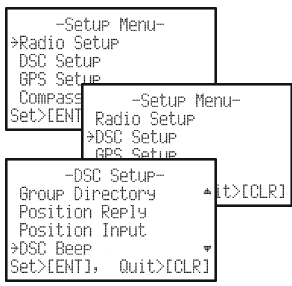

6. Press the [▼] key to select “Off”.
7. Press the [CLR(MEM)] key twice to return to the “Setup Menu”, then press the [CLR(WX)] key again to return to radio operation.

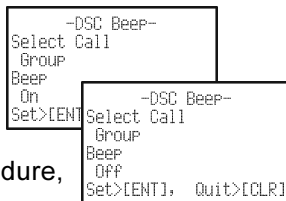

To enable the ringer tone, repeat the above procedure, press the [▲] key to select “On” in step “6” above.

7.7.3 TRANSMITTING A GROUP CALL

Pre-Programmable Calling

1. Press the [CALL(ENT)MENU] key. The “DSC Call Menu” will appear.
2. Press the [▼] / [▲] key to select “Group”. (To cancel, press the [CLR(WX)] key.)
3. Press the [CALL(ENT)MENU] key. The transceiver will beep, and the “Group Call” directory will appear.
4. Press the [▼] / [▲] key to select “Group” you want to contact.
5. Press the [CALL(ENT)MENU] key, then press the [▼] / [▲] key to select the operating channel you want to communicate on and press the [CALL(ENT)MENU] key.
6. Press the [CALL(ENT)MENU] key again to transmit the Group Call signal.
7. When the Group Call signal is sent, the display will be as shown in the illustration at the right.
8. After the GROUP CALL is transmitted, all the radios in the group will switch to the designated channel.
9. Listen to the channel to make sure it is not busy, then press the PTT switch and call the other vessels you desire to communicate with.

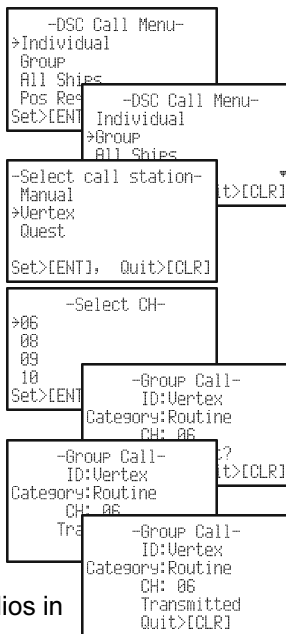

Manual Calling

You may enter a Group MMSI number manually to contact without the Setting up a Group call number.

1. Press the [CALL(ENT)MENU] key. The “DSC Call Menu” will appear.
2. Press the [▼] / [▲] key to select “Group”. (To cancel, press the [CLR(MEM)] key.)
3. Press the [CALL(ENT)MENU] key. The transceiver will beep, and the “Group Call” directory will appear.

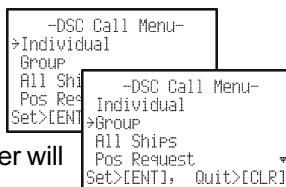

4. Press the [▼] / [▲] key to select “Manual”, then press the [CALL(ENT)MENU] key.
5. Press the [▼] / [▲] key to scroll through numbers, 0-9. To enter the desired number and move one space to the right press the [CALL(ENT)MENU] key. Repeat this procedure until all nine space of the MMSI number which you want to contact are entered. If a mistake was made entering in the MMSI number repeatedly press the [H/L(On)] key until the wrong number is selected, then press the [▼] / [▲] key to correct the entry.
6. When finished entering the MMSI number, press and hold the [CALL(ENT)MENU] key. The transceiver will beep, and the “Select Intership CH” menu will appear
7. Press the [▼] / [▲] key to select “Manual”, then press the [CALL(ENT)MENU] key.
8. Press the [▼] / [▲] key to select the operating channel you want to communicate on and press the [CALL(ENT)MENU] key.
9. Press the [CALL(ENT)MENU] key again to transmit the Group Call signal.
10. When the Group Call signal is sent, the display will be as shown in the illustration at the right.
11. After the Group Call is transmitted, all the radios in the group will switch to the designated channel.
12. Listen to the channel to make sure it is not busy, then press the PTT switch and call the other vessels you desire to communicate with.

```
-Select call station-
>Manual
Vertex
Quest
Set>[ENT]
```

```
-Manual Input-
Input Group ID
0-----
Set>[ENT], Quit>[CLR]
```

```
-Manual Input-
Input Group ID
012345678
Set>[ENT]
```

```
-Select CH-
>06
08
09
10
Set>[ENT], Quit>[CLR]
```

```
-Select CH-
72
73
77
>Manual
Set>[ENT], Quit>[CLR]
```

```
- Manual Select CH-
68
```

```
-Group Call-
ID:012345678
Category:Routine
CH: 68
Transmit?
Yes>[ENT], Quit>[CLR]
```

```
-Group Call-
ID:012345678
Category:Routine
CH: 68
Transmitting
```

```
-Group Call-
ID:012345678
Category:Routine
CH: 68
Transmitted
Quit>[CLR]
```

7.7.4 RECEIVING A GROUP CALL

1. When a Group Call is received, the **HX851** will produce a ringing alarm sound and the display shows the Group name or Group MMSI.
2. Press any key to stop the alarm.
3. Press the [**CALL(ENT)MENU**] key to switch the radio to the requested channel.
4. Monitor the channel for the person calling the Group for a message.
5. If you want to respond, monitor the channel to make sure it is clear, then press the **PTT** switch and talk to the calling ship(s).

```
Received Group  
ID: Standard  
Category: Routine  
CH: 68  
Yes>[ENT], Quit>[CLR]
```

NOTE

After a Group Call is received, the time the call was made and the ships MMSI or vessels name will appear on the display.

7.8 POSITION REQUEST

Advancements in DSC have made it possible to poll the location of another vessel and show the position of that vessel on the display of the **HX851**. Standard Horizon has taken this feature one step further, if any Standard Horizon GPS chart plotter is connected to the **HX851** through the **CD-38**, the polled position of the vessel is shown on the display of the GPS chart plotter making it easy to navigate to the location of the polled vessel. This is a great feature for anyone wanting to know the position of another vessel. For example your buddy that is catching fish, or finding the location of a person you are cruising with.

NOTE

The other vessel must have an operating GPS receiver connected to its DSC transceiver and must not have its transceiver set to deny position requests. (Refer the section “7.5 INDIVIDUAL CALL” to enter information into the Individual Directory).

7.8.1 SETTING UP POSITION REPLY

The **HX851** can be set up to “automatically” or “manually” send your position to another vessel. This selection is important if you are concerned about someone polling the position of your vessel that you may not want to. In the “Manual” mode you will see the MMSI or persons name shown on the display allowing you to choose to send your position to the requesting vessel.

1. Press and hold the **[CALL(ENT)MENU]** key until “Setup Menu” appears.
2. Press the **[▼]** key to select “DSC Setup” menu.
3. Press the **[CALL(ENT)MENU]** key, then select “Position Reply” with the **[▼]** / **[▲]** key.
4. Press the **[CALL(ENT)MENU]** key.
5. Press the **[▼]** / **[▲]** key to select “Automatic” or “Manual”. In “Automatic” mode, after a DSC POS Request is received, the radio will automatically transmit your vessels position. In “Manual” mode, the display of the **HX851** will show who is requesting the position.
6. Press the **[CALL(ENT)MENU]** key to store the selected setting.
7. Press the **[CLR(MEM)]** key twice to return to radio operation.

```
-Setup Menu-
  ↳Radio Setup
  DSC Setup
  GPS Set
  Compass
  Set>[ENT]

-Setup Menu-
  ↳Radio Setup
  ↳DSC Setup
  ↳GPS Setup
  ↳Compass Setup
  Set>[ENT], Quit>[CLR]

-DSC Setup-
  ↳Individual Directory
  ↳Individual Reply
  ↳Individual Ack
  ↳Individual Ringer
  Set>[ENT], Quit>[CLR]

-Individual Reply-
  ↳Automatic
  ↳Manual
  Set>[ENT], Quit>[CLR]
```

7.8.2 SETTING UP THE POSITION REQUEST RINGER

The **HX851** has the capability to turn off the Position Request ringer.

1. Press and hold the **[CALL(ENT)MENU]** key until “Setup Menu” appears.
2. Press the **[▼]** key to select “DSC Setup” menu.
3. Press the **[CALL(ENT)MENU]** key, then select “DSC Beep” with the **[▼]** / **[▲]** key.
4. Press the **[CALL(ENT)MENU]** key.
5. Press the **[▼]** / **[▲]** key to select “Position Request”, then press the **[CALL(ENT)MENU]** key.
6. Press the **[▼]** key to select “Off”.
7. Press the **[CLR(MEM)]** key twice to return to the “Setup Menu”, then press the **[CLR(WX)]** key again to return to radio operation.

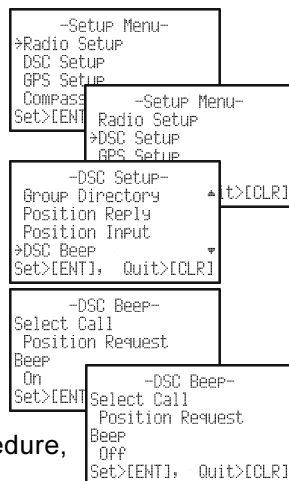

To enable the ringer tone, repeat the above procedure, press the **[▲]** key to select “On” in step “6” above.

7.8.3 TRANSMITTING A POSITION REQUEST TO ANOTHER VESSEL

Pre-Programmable Request

1. Press the **[CALL(ENT)MENU]** key. The “DSC Call Menu” will appear in the display.
2. Press the **[▼]** / **[▲]** key to select the “Pos Request”.
3. Press **[CALL(ENT)MENU]** key to show the “Position Request Call” directory. This directory uses the “Individual Call” directory information.
4. Press the **[▼]** / **[▲]** key to select a name, then press the **[CALL(ENT)MENU]** key.
5. Press the **[CALL(ENT)MENU]** key again to transmit the Position Request DSC call.
6. When the **HX851** receives the position from the polled vessel, a ringing alarm will sound, and the display shows the position of the vessel and also transferred to a GPS Chart plotter if connected.
7. Press any key to stop the alarm.
8. If you wish to display the position of the polled vessel on the “WAYPOINT” screen, go to next step, otherwise press the **[CLR(WX)]** key to return to radio operation.

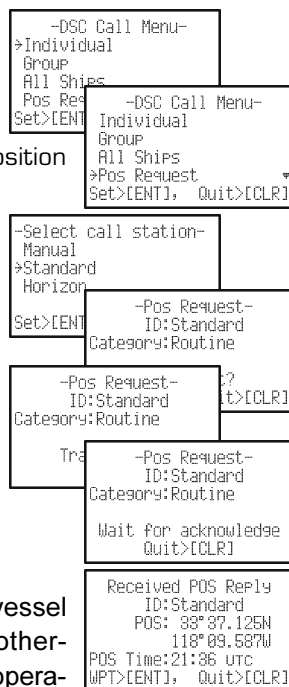

9. Press the [CALL(ENT)MENU] key to enter the “Waypoint Input” menu.
10. Press and hold the [CALL(ENT)MENU] key several times until replace the display to the “WAYPOINT” Screen. The display indicates the distance and direction of the polled vessel, and also the compass indicates the polled vessel by dot (●).
11. To stop navigating to the location of the position request call:



- 1) Press and hold down the [CALL(ENT)MENU] key until “Setup Menu” appears.
- 2) Press the [▼] / [▲] key to select “Radio Setup”.
- 3) Press the [CALL(ENT)MENU] key, then select “Display” with the [▼] / [▲] key.
- 4) Press the [CALL(ENT)MENU] key, and select “Radio”, “Position”, “Navigation” or “Compass” other than “Waypoint”, and press the [CALL(ENT)MENU] key.

NOTE

If the HX851 does not receive position data from the polled vessel, the display will show “NO POSITION DATA”.

Manual Request

You may enter an MMSI number manually to contact without Setting up the Individual / Position Call Directory.

1. Press the [CALL(ENT)MENU] key. The “DSC Call Menu” will appear in the display.
2. Press the [▼] / [▲] key to select the “Pos Request”.
3. Press [CALL(ENT)MENU] key to show the “Position Request Call” directory. This directory uses the “Individual Call” directory information.
4. Press the [▼] / [▲] key to select the “Manual”, then press the [CALL(ENT)MENU] key.
5. Press the [▼] / [▲] key to scroll through numbers, 0-9. To enter the desired number and move one space to the right press the [CALL(ENT)MENU] key. Repeat this procedure until all nine spaces of the MMSI number which you want to contact are entered. If a mistake was made entering in the MMSI number repeatedly press the [H/L (On)] key until the wrong number is se-

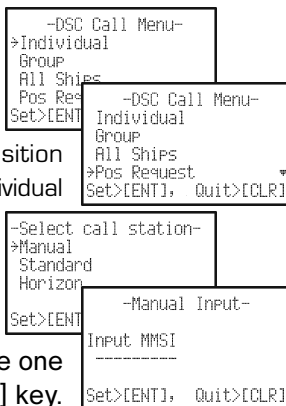

lected, then press the [▼] / [▲] key to correct the entry.

6. When finished entering the MMSI number, press and hold the [CALL(ENT)MENU] key.
7. Press the [CALL(ENT)MENU] key to transmit the position request DSC call.
8. When the **HX851** receives the position from the polled vessel, a ringing alarm will sound, and the display shows the position of the vessel and also transferred to the GPS Chart plotter if connected.
9. Press any key to stop the alarm.
10. If you wish to display the position of the polled vessel on the "WAYPOINT" screen, go to next step, otherwise press the [CLR(WX)] key to return to radio operation.
11. Press the [CALL(ENT)MENU] key to enter the "Waypoint Input" menu, then enter the desired waypoint name (up to 11 characters), described previously (select the letter/number by pressing the [▼] / [▲] key and move the cursor by pressing the [CALL(ENT)MENU] / [H/L(On)] key).
12. The ID is the MMSI from the polled vessel.
13. When you are finished entering the waypoint name, press and hold the [CALL(ENT)MENU] key several times until replace the display to the "WAYPOINT" Screen. The display indicates the distance and direction of the polled vessel, and also the compass indicates the polled vessel by dot (●).
14. To stop navigating to the location of the position request call:
 - 1) Press and hold down the [CALL(ENT)MENU] key until "Setup Menu" appears.
 - 2) Press the [▼] / [▲] key to select "Radio Setup".
 - 3) Press the [CALL(ENT)MENU] key, then select "Display" with the [▼] / [▲] key.
 - 4) Press the [CALL(ENT)MENU] key, and select "Radio", "Position", "Navigation" or "Compass" other than "Waypoint", and press the [CALL(ENT)MENU] key.

```
-Manual Input-
Input MMSI
234567891
Set>[ENT], Quit>[CLR]
```

```
-Pos Request-
ID:234567891
Category:Routine
Transmit?
Yes>[ENT], Quit>[CLR]
```

```
-Pos Request-
ID:234567891
Category:Routine
Transmitting
```

```
-Pos Request-
ID:234567891
Category:Routine
Wait for acknowledge
Quit>[CLR]
```

```
Received POS Reply
ID:234567891
POS: 33° 37.125N
118° 09.587W
POS Time:21:36 utc
WPT>[ENT], Quit>[CLR]
```

```
-Waypoint Input-
WPT Name:_
ID:123456789
Position: 33° 37.125N
118° 09.587W
Set>[ENT], Quit>[CLR]
```

```
-Waypoint Input-
WPT Name:Horizon
ID:123456789
Position: 33° 37.125N
118° 09.587W
Set>[ENT], Quit>[CLR]
```



7.8.4 RECEIVING A POSITION REQUEST

When a Position Request Call is received from another vessel and a ringing alarm will sound. Operation and transceiver function differs depending on “Position Reply” menu in the “DSC Setup” menu setting. Refer to section “7.8.1 SETTING UP POSITION REPLY”.

Automatically reply:

1. When a Position Request Call is received, a calling alarm sounds 5 times. Then requested position coordinates are transmitted automatically to the vessel requesting your vessels position.
2. To exit from Position Request display, press the **[CLR(WX)]** key.

```
Received POS Request
  ID:Standard
Category:Routine

  Replied
  Quit>[CLR]
```

Manually reply:

1. When a Position Request Call is received from another vessel, the display will be as shown in the illustration at the right and a ringing alarm will sound.
2. Press any key to stop the alarm.
3. To send your vessels position to the requesting vessel, press the **[CALL(ENT)MENU]** key. Or to exit from position request display, press the **[CLR(WX)]** key.

```
Received POS Request
  ID:Standard
Category:Routine

  Reply?
Reply>[ENT],Quit>[CLR]
```

7.9 POSITION REPORT

The feature is similar to Position Request, however instead of requesting a position of another vessel this function allows you to send your position to another vessel.

NOTE

To transmit a Position Send Call, you must setup the **HX851** DSC Individual / Position Call Directory with the name of the vessel(s) or person and the MMSI of the DSC radio you wish to send your position to. To setup this directory refer to section “**7.5.1 SETTING UP THE INDIVIDUAL / POSITION CALL DIRECTORY**”.

7.9.1 SETTING UP A POSITION REPORT RINGER

The **HX851** has the capability to turn off the Position Report ringer.

1. Press and hold the **[CALL(ENT)MENU]** key until “Setup Menu” appears.
2. Press the **[▼]** key to select “DSC Setup” menu.
3. Press the **[CALL(ENT)MENU]** key, then select “DSC Beep” with the **[▼]** / **[▲]** key.
4. Press the **[CALL(ENT)MENU]** key, then select “Position Report” with the **[▼]** / **[▲]** key.
5. Press the **[CALL(ENT)MENU]** key, then press the **[▼]** key to select “Off”.
6. Press the **[CALL(ENT)MENU]** key to store the selected setting.
7. Press the **[CLR(WX)]** key twice to return to the “Setup Menu”, then press the **[CLR(WX)]** key again to return to radio operation.

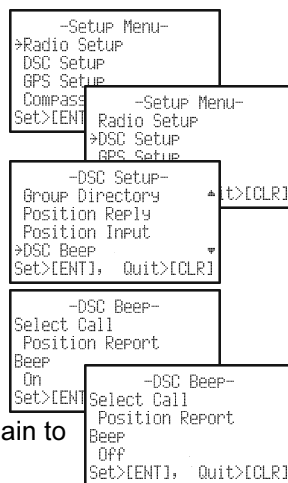

To return to enabling the ringer tone, repeat the above procedure, press the **[▲]** key to select “On” in step “5” above.

7.9.2 TRANSMITTING A DSC POSITION REPORT CALL

Pre-Programmable Calling

1. Press the **[CALL(ENT)MENU]** key. The “DSC Call Menu” will appear in the display.
2. Press the **[▼] / [▲]** key to select the “Pos Report”.
3. Press **[CALL(ENT)MENU]** key to show the “POS Report Call” Directory. This directory uses the “Individual Call” Directory information.
4. Press the **[▼] / [▲]** key to select a name in the directory, then press the **[CALL(ENT)MENU]** key.
5. Press the **[CALL(ENT)MENU]** key again to send your position to the selected vessel.
6. Press the **[CLR(WX)]** key to return to radio operation.

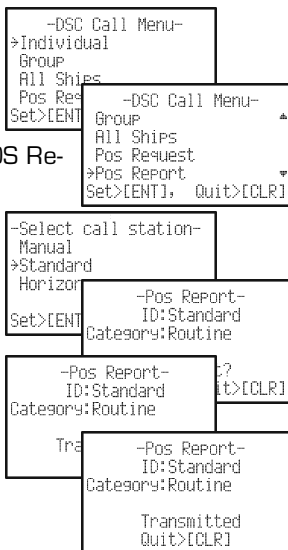

Manual Calling

You may enter an MMSI number manually to contact another vessel without setting up the Individual / Position Call Directory.

1. Press the **[CALL(ENT)MENU]** key. The “DSC Call Menu” will appear in the display.
2. Press the **[▼] / [▲]** key to select the “Pos Report”.
3. Press **[CALL(ENT)MENU]** key to show the “POS Report Call” Directory. This directory uses the “Individual Call” Directory information.
4. Press the **[▼] / [▲]** key to select “Manual”, then press the **[CALL(ENT)MENU]** key.
5. Press the **[▼] / [▲]** key to scroll through numbers, 0-9. To enter the desired number and move one space to the right press the **[CALL(ENT)MENU]** key.
6. Repeat this procedure until all nine spaces of the MMSI number which you want to contact are entered. If a mistake was made entering in the MMSI number repeatedly press the **[H/L(On)]** key until the wrong number is selected, then press the **[▼] / [▲]** key to correct the entry.

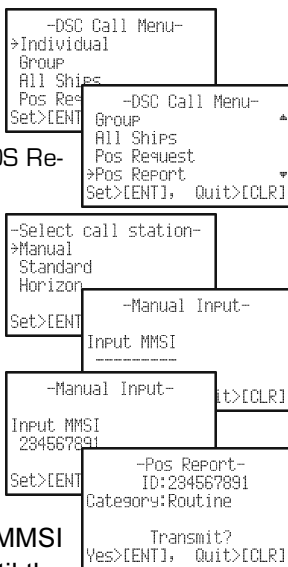

7. When finished entering the MMSI number, press and hold the **[CALL(ENT)MENU]** key.
8. Press the **[CALL(ENT)MENU]** key again to send your position to the selected vessel.
9. Press the **[CLR(WX)]** key to return to radio operation.

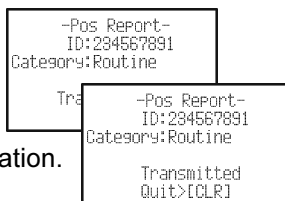

7.9.3 RECEIVING A DSC POSITION REPORT CALL

When another vessel transmits their vessels location to the **HX851** the following will happen:

1. When a Position Report Call is received, a calling alarm sounds 5 times and NMEA DSC and DSE sentences are outputted on the charging cradle wires.
2. The display shows the position from the vessel sending it's position and also transferred to any compatible GPS Chart plotter if connected.
3. If you wish to display the position of the received vessel on the "WAYPOINT" screen, go to next step, otherwise press the **[CLR(WX)]** key to return to radio operation.
4. Press the **[CALL(ENT)MENU]** key to enter the "Waypoint Input" menu, then enter the desired waypoint name (up to 11 characters), described previously (select the letter/number by pressing the **[▼]** / **[▲]** key and move the cursor by pressing the **[CALL(ENT)MENU]** / **[H/L(On)]** key).
5. The ID is the MMSI from the received vessel.
6. When you are finished entering the waypoint name, press and hold the **[CALL(ENT)MENU]** key several times until the "WAYPOINT" display is shown. The display indicates the distance and direction of the received vessel, and also the compass indicates the received vessel by dot (●).
7. To stop navigating to the location of the position request call:
 - 1) Press and hold down the **[CALL(ENT)MENU]** key until "Setup Menu" appears.
 - 2) Press the **[▼]** / **[▲]** key to select "Radio Setup".
 - 3) Press the **[CALL(ENT)MENU]** key, then select "Display" with the **[▼]** / **[▲]** key.
 - 4) Press the **[CALL(ENT)MENU]** key, and select "Radio", "Position", "Navigation" or "Compass" other than "Waypoint", and press the **[CALL(ENT)MENU]** key.

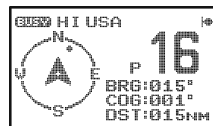
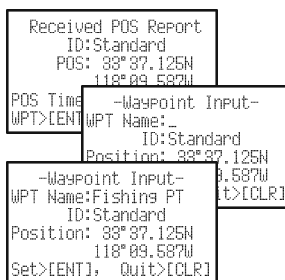

7.10 GEOGRAPHIC CALL

The **HX851** can receive the Geographic Calls from another station.

1. When the Geographic Call is received, a ringing sound will be produced and the display shows the MMSI* (or name) of the station transmitting the Geographic Call.
2. Press any key to stop the alarm.
3. Press the **[CALL(ENT)MENU]** key to switch the radio to the requested channel.
4. Press the **PTT** on the mic and talk to the calling station.

```
Received Geographic  
ID:Standard  
Category:Urgency  
CH: 06  
Quit>[CLR]
```

7.10.1 SETTING UP THE POSITION GEOGRAPHIC RINGER

The **HX851** has the capability to turn off the Geographic ringer.

1. Press and hold the **[CALL(ENT)MENU]** key until "Setup Menu" appears.
2. Press the **[▼]** key to select "DSC Setup" menu.
3. Press the **[CALL(ENT)MENU]** key, then select "DSC Beep" with the **[▼] / [▲]** key.
4. Press the **[CALL(ENT)MENU]** key.
5. Press the **[▼] / [▲]** key to select "Geographic", then press the **[CALL(ENT)MENU]** key.
6. Press the **[▼]** key to select "Off".
7. Press the **[CLR(MEM)]** key twice to return to the "Setup Menu", then press the **[CLR(WX)]** key again to return to radio operation.

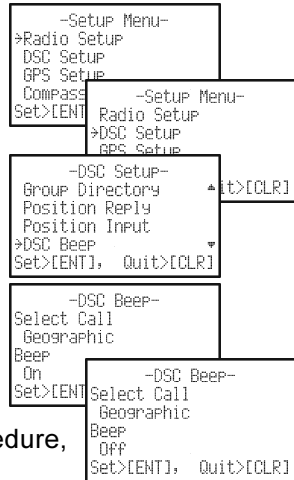

To enable the ringer tone, repeat the above procedure, press the **[▲]** key to select "On" in step "6" above.

7.11 DSC TRANSMISSION TEST

Use the following procedure to ensure the DSC feature is functioning with another DSC radio.

1. Press the [CALL(ENT)MENU] key. The “DSC Call Menu” will appear in the display.
2. Press the [▼] / [▲] keys to select the “DSC Test”, then press the [CALL(ENT)MENU] key.
3. Choose a or b below:
 - a. **Select MMSI from Individual directory:**
 Select the station (name or MMSI number) using the [▼] / [▲] keys the DSC test signal will be transmitted to, then press the [CALL(ENT)MENU] key. Go to step 4.
 - b. **Manually enter MMSI of know vessel or station:**
 Select “Manual” using the [▼] / [▲] keys, then press the [CALL(ENT)MENU] key and enter the MMSI number (nine digits) which you want to send the test signal. To do this, press the [▼] / [▲] keys to scroll through numbers “0-9,” then press the [CALL(ENT)MENU] key to move the entry location to the right. If a mistake was made entering in the MMSI number, repeat pressing the [H/L (On)] key until the wrong number is selected, then press the [▼] / [▲] keys to correct the entry. When finished entering the MMSI number, press and hold the [CALL(ENT)MENU] key.
4. Press the [CALL(ENT)MENU] key again to transmit the Test signal.
5. If the reply signal is not received from the vessel or station the test call was sent to, “WAIT FOR ACK” will be shown on the display.
6. When an acknowledgment is received, a ringing tone sounds.
7. Press the [CLR(WX)] key to return the display to the radio operation mode display.

```
-DSC Call Menu-
>Individual
  Group
  All Ships
  Pos Res
  Pos REP
```

```
-DSC Call Menu-
  All Ships
  Pos Request
  Pos Report
  DSC Log
  >DSC Test
```

```
-DSC Test Call-
Select call station.
Manual
>Standard
  Horizon
  Exit
```

```
-DSC Test Call-
Select call station.
>Manual
  Standard
  Horizon
  Exit
```

```
-DSC Test Call-
Input MMSI.
MMSI
-----
Set>[ENT], Clear>[CLR]
```

```
-DSC Test Call-
Input MMSI.
MMSI
234567891
Set>[ENT], Clear>[CLR]
```

```
-DSC Test Call-
Standard

Transmit[ENT]
Cancel [CLR]
```

```
HI USA HI
Test
Waiting for
acknowledge
Standard
Exit[CLR] 70
```

```
HI USA HI
Received
Test ACK
Standard
Exit[CLR] 06
```

8 RADIO SETUP

The **HX851**'s "Radio Setup" mode allows a number of the **HX851** operating parameters to be custom-configured for your operating requirements.

8.1 DISPLAY

Allows setting up the **HX851** display mode. The default setting is "Position".

1. Press and hold the [CALL(ENT)MENU] key until "Setup Menu" appears.
2. Press the [CALL(ENT)MENU] key, then select "Display" in the "Radio Setup" menu with the [▼] / [▲] key.
3. Press the [CALL(ENT)MENU] key.
4. Press the [▼] / [▲] key to select the desired mode.

```

-Setup Menu-
>Radio Setup
DSC Setup
GPS Setup
Compass Setup
Set>[ENT], Quit>[CLR]
    
```

```

-Radio Setup-
>Display
Dimmer
Contrast
Lamp
Set>[ENT], Quit>[CLR]
    
```

```

-Display-
>Radio
Position
Navigation
Compass
Set>[ENT], Quit>[CLR]
    
```

- Radio: Displays the "☰" icon only.
- Position: Displays your position and current time on the display.
- Navigation: Displays your position, SOG (Speed Over Ground: your current speed), COG (Course Over Ground: your current direction), and current time on the display.
- Compass: Displays your SOG (Speed Over Ground: your current speed), COG (Course Over Ground: your current direction) by the Rose Compass.
- Waypoint: Displays the distance and direction of the received vessel, and also the compass indicates the received vessel by dot (●).
- GPS Status: Displays apparent reception of GPS satellites, including the bar-graph of signal strengths.
5. Press the [CALL(ENT)MENU] key to store the selected display and return to radio operation mode.

NOTE

When the "GPS Status" mode is selected in step "4" above, the display will show the "GPS Status" page until pressing any key.



"RADIO" MODE



"POSITION" MODE

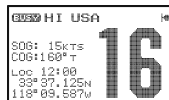

"NAVIGATION" MODE



"COMPASS" MODE

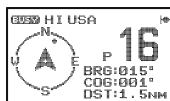

"WAYPOINT" MODE

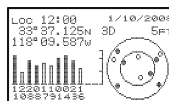

"GPS STATUS" MODE

8.2 DIMMER

Allows setting up the display/keypad backlight intensity or to turn it off. The default setting is “High”.

1. Press and hold the [CALL(ENT)MENU] key until “Setup Menu” appears.
2. Press the [CALL(ENT)MENU] key, then select “Dimmer” in the “Radio Setup” menu with the [▼] / [▲] key.
3. Press the [CALL(ENT)MENU] key.
4. Press the [▼] / [▲] key to select the desired level. The dimmer level can be set to “1/2/3/4/5/6/High” or “Off”. When “Off” is selected, the lamp is extinguished.
5. Press the [CALL(ENT)MENU] key to store the selected level.
6. To exit this menu and return to radio operation mode press the [16/9] key or press the [CLR(WX)] key several times.

```
-Setup Menu-
>Radio Setup
  DSC Setup
  GPS Setup
  Compass Setup
Set>[ENT], Quit>[CLR]
```

```
-Radio Setup-
  Display
  Dimmer
  Contrast
  Lamp
Set>[ENT], Quit>[CLR]
```

```
-Dimmer-
>High
  6
  5
  4
Set>[ENT], Quit>[CLR]
```

8.3 CONTRAST

The contrast may be changed for best viewing in sunlight, dusk or night allowing for best readability. The default setting is “9”.

1. Press and hold the [CALL(ENT)MENU] key until “Setup Menu” appears.
2. Press the [CALL(ENT)MENU] key, then select “Contrast” in the “Radio Setup” menu with the [▼] / [▲] key.
3. Press the [CALL(ENT)MENU] key.
4. Press the [▼] / [▲] key to select the desired level. The contrast level can be set from “0” to “20”.
5. Press the [CALL(ENT)MENU] key to store the selected level.
6. To exit this menu and return to radio operation mode press the [16/9] key or press the [CLR(WX)] key several times.

```
-Setup Menu-
>Radio Setup
  DSC Setup
  GPS Setup
  Compass Setup
Set>[ENT], Quit>[CLR]
```

```
-Radio Setup-
  Display
  Dimmer
  >Contrast
  Lamp
Set>[ENT], Quit>[CLR]
```

```
-Contrast-
  18
  17
  16
  >15
Set>[ENT], Quit>[CLR]
```

8.4 LAMP

This menu selection is used to setup the illumination time of the display and keypad. The default setting is “5 Seconds”.

1. Press and hold the [CALL(ENT)MENU] key until “Setup Menu” appears.
2. Press the [CALL(ENT)MENU] key, then select “Lamp” in the “Radio Setup” menu with the [▼] / [▲] key.
3. Press the [CALL(ENT)MENU] key.
4. Press the [▼] / [▲] key to select the desired time.

```
-Setup Menu-
>Radio Setup
DSC Setup
BPS Setup
Compass Setup
Set>[ENT], Quit>[CLR]
```

```
-Radio Setup-
Display
Dimmer
Contrast
>Lamp
Set>[ENT], Quit>[CLR]
```

```
-LAMP-
>Continuous
30 Seconds
25 Seconds
20 Seconds
Set>[ENT], Quit>[CLR]
```

Continuous: Illuminates the display/keypad continuously.

1/2/3/4/5/6/8/10/12/15/20/25/30 Seconds:

Illuminates the display/keypad for the selected time when press any key (except the PTT switch).

Off: Disables the display/keypad lamp illumination.

5. Press the [CALL(ENT)MENU] key to store the selected setting.
6. To exit this menu and return to radio operation mode press the [16/9] key or press the [CLR(WX)] key several times.

8.5 PRIORITY CHANNEL

Allows selection of the priority channel when priority scan is enabled. The default setting is “Channel 16”.

1. Press and hold the [CALL(ENT)MENU] key until “Setup Menu” appears.
2. Press the [CALL(ENT)MENU] key, then select “Priority CH” in the “Radio Setup” menu with the [▼] / [▲] key.
3. Press the [CALL(ENT)MENU] key.
4. Press the [▼] / [▲] key to select the desired channel to be a priority.
5. Press the [CALL(ENT)MENU] key to store the selected setting.
6. To exit this menu and return to radio operation mode press the [16/9] key or press the [CLR(WX)] key several times.

```
-Setup Menu-
>Radio Setup
DSC Setup
BPS Setup
Compass Setup
Set>[ENT], Quit>[CLR]
```

```
-Radio Setup-
Dimmer
Contrast
Lamp
>Priority CH
Set>[ENT], Quit>[CLR]
```

```
-Priority CH-
19A
18A
17
>16
Set>[ENT], Quit>[CLR]
```

8.6 SCAN TYPE

This selection is used to select the scan mode between “Memory Scan” and “Priority Scan.” The default setting is “Priority SCAN”.

1. Press and hold the [CALL(ENT)MENU] key until “Setup Menu” appears.
2. Press the [CALL(ENT)MENU] key, then select “SCAN Type” in the “Radio Setup” menu with the [▼] / [▲] key.
3. Press the [CALL(ENT)MENU] key.
4. Press the [▼] / [▲] key to select “Priority SCAN” or “Memory SCAN”.
5. Press the [CALL(ENT)MENU] key to store the selected setting.
6. To exit this menu and return to radio operation mode press the [16/9] key or press the [CLR(WX)] key several times.

```
-Setup Menu-
>Radio Setup
DSC Setup
GPS Setup
Compass Setup
Set>[ENT], Quit>[CLR]
```

```
-Radio Setup-
Contrast
Lamp
Priority CH
>SCAN Type
Set>[ENT], Quit>[CLR]
```

```
-SCAN Type-
>Priority SCAN
Memory SCAN
Set>[ENT], Quit>[CLR]
```

8.7 SCAN MEMORY

To be able to scan channels the radio must be programmed. This section allows channels to be stored in scan memory.

1. Press and hold the [CALL(ENT)MENU] key until “Setup Menu” appears.
2. Press the [CALL(ENT)MENU] key, then select “SCAN Memory” in the “Radio Setup” menu with the [▼] / [▲] key.
3. Press the [CALL(ENT)MENU] key.
4. Press the [▼] / [▲] key to select a desired channel to be scanned, then press the [CALL(ENT)MENU] key. “MEM” icon appears on the display, which indicates the channel has been selected to the scan channel.
5. Repeat step 4 for all the desired channels to be scanned.
6. To DELETE a channel from the list, select the channel then press the [CALL(ENT)MENU] key. “MEM” icon disappears from the display.
7. When you have completed your selection, press the [16/9] key or press the [CLR(WX)] several times to return to radio operation.

```
-Setup Menu-
>Radio Setup
DSC Setup
GPS Setup
Compass Setup
Set>[ENT], Quit>[CLR]
```

```
-Radio Setup-
Lamp
Priority CH
SCAN Type
>SCAN Memory
Set>[ENT], Quit>[CLR]
```

```
-SCAN Memory-
>01A
03A
05A
06
Set>[ENT], Quit>[CLR]
```

```
-SCAN Memory-
>01A MEM
03A
05A
06
Set>[ENT], Quit>[CLR]
```

8.8 SCAN RESUME

This selection is used to select the time which the **HX851** waits after a transmission ends before scanning is started. The default setting is “2sec”.

1. Press and hold the [**CALL(ENT)MENU**] key until “Setup Menu” appears.
2. Press the [**CALL(ENT)MENU**] key, then select “SCAN Resume” in the “Radio Setup” menu with the [▼] / [▲] key.
3. Press the [**CALL(ENT)MENU**] key.
4. Press the [▼] / [▲] key to select the desired resume time. The resume time can be set to “1/2/3/4/5 sec” or “Off”. In the “Off” selection, the scanner will resume after the other station stops transmitting (carrier drops).
5. Press the [**CALL(ENT)MENU**] key to store the selected setting.
6. To exit this menu and return to radio operation mode press the [**16/9**] key or press the [**CLR(WX)**] key several times.

```
-Setup Menu-
>Radio Setup
DSC Setup
GPS Setup
Compass Setup
Set>[ENT], Quit>[CLR]
```

```
-Radio Setup-
Priority CH
SCAN Type
SCAN Memory
>SCAN Resume
Set>[ENT], Quit>[CLR]
```

```
-SCAN Resume-
Off
1sec
>2sec
3sec
Set>[ENT], Quit>[CLR]
```

8.9 KEY BEEP

This selection controls the loudness of the key beep or turns it off. The default setting is “Level 5”.

1. Press and hold the [**CALL(ENT)MENU**] key until “Setup Menu” appears.
2. Press the [**CALL(ENT)MENU**] key, then select “Key Beep” in the “Radio Setup” menu with the [▼] / [▲] key.
3. Press the [**CALL(ENT)MENU**] key.
4. Press the [▼] / [▲] key to select the desired beep level. The beep level can be set to “Level 1”, “Level 2”, “Level 3”, “Level 4”, “Level 5”, “Level 6”, “High”, or “Off”.
5. Press the [**CALL(ENT)MENU**] key to store the selected setting.
6. To exit this menu and return to radio operation mode press the [**16/9**] key or press the [**CLR(WX)**] key several times.

```
-Setup Menu-
>Radio Setup
DSC Setup
GPS Setup
Compass Setup
Set>[ENT], Quit>[CLR]
```

```
-Radio Setup-
SCAN Type
SCAN Memory
SCAN Resume
>Key Beep
Set>[ENT], Quit>[CLR]
```

```
-Key Beep-
>High
Level 6
Level 5
Level 4
Set>[ENT], Quit>[CLR]
```

8.10 WEATHER ALERT

This selection allows the NOAA Weather Alert to be setup. The default setting is “ON SCAN and WX CH”.

1. Press and hold the [CALL(ENT)MENU] key until “Setup Menu” appears.
2. Press the [CALL(ENT)MENU] key, then select “Weather Alert” in the “Radio Setup” menu with the [▼] / [▲] key.
3. Press the [CALL(ENT)MENU] key.
4. Press the [▼] / [▲] key to select the desired Weather Alert mode.

```

-Setup Menu-
->Radio Setup
DSC Setup
GPS Setup
Compass Setup
Set>[ENT], Quit>[CLR]
    
```

```

-Radio Setup-
SCAN Memory
SCAN Resume
Key Beep
->Weather Alert
Set>[ENT], Quit>[CLR]
    
```

```

-Weather Alert-
On WX CH
On SCAN
->On SCAN and WX CH
Off
Set>[ENT], Quit>[CLR]
    
```

- ON WX CH: Emits a loud beep when the Weather Alert is received while receiving the Weather channel.
 - ON SCAN: Emits a loud beep when the Weather Alert is received while scanning the Weather channels.
 - ON SCAN and WX CH: Emits a loud beep when the Weather Alert is received while receiving the Weather channel and/or scanning the Weather channels.
 - Off: Disable the Weather Alert function.
5. Press the [CALL(ENT)MENU] key to store the selected setting.
 6. To exit this menu and return to radio operation mode press the [16/9] key or press the [CLR(WX)] key several times.

8.11 CHANNEL NAME

This selection allows you to customize the name of a channel from the default name.

Example: CH69 PLEASURE to HOOKUP

1. Press and hold the [CALL(ENT)MENU] key until “Setup Menu” appears.
2. Press the [CALL(ENT)MENU] key, then select “CH Name” in the “Radio Setup” menu with the [▼] / [▲] key.
3. Press the [CALL(ENT)MENU] key.
4. Press the [▼] / [▲] key to select the channel to be named (In this case, select to “69”) and press the [CALL(ENT)MENU] key.
5. Press the [▼] / [▲] key to scroll through the alphabet and 0 - 9. Enter the first letter of channel name.
6. Press the [CALL(ENT)MENU] key to enter the desired letter and move the cursor one space to the right.
7. Repeat the procedure until the name is complete. The name can consist of up to 11 characters. If you do not use all 11 characters, press the [CALL(ENT)MENU] key to move to the next space. This method can also be used to enter a blank space in the name. To clear the previous letter, press the [CLR(WX)] key.
8. If a mistake was made entering repeatedly press the [H/L(On)] key until the wrong character is selected, then press the [▼] / [▲] key to correct the entry.
9. Press and hold down the [CALL(ENT)MENU] key to enter the name.
10. If you want to enter the name of another channel, repeat steps 4 through 9.
11. To exit this menu and return to radio operation mode press the [16/9] key or press the [CLR(WX)] key several times.

```
-Setup Menu-
->Radio Setup
DSC Setup
BPS Setup
Compass Setup
Set>[ENT], Quit>[CLR]
```

```
-Radio Setup-
SCAN Resume
Key Beep
Weather Alert
->CH Name
Set>[ENT], Quit>[CLR]
```

```
-Radio Setup-
Select CH
69
CH Name
PLEASURE
Set>[ENT], Quit>[CLR]
```

```
-Radio Setup-
Select CH
69
CH Name
HLEASURE
Set>[ENT], Quit>[CLR]
```

```
-Radio Setup-
Select CH
69
CH Name
HOOKUPRE
Set>[ENT], Quit>[CLR]
```

```
-Radio Setup-
Select CH
69
CH Name
HOOKUP
Set>[ENT], Quit>[CLR]
```

8.12 LED SETUP

Allows setting up the **TX/BUSY** LED mode. The default setting is “Continuous”.

1. Press and hold the **[CALL(ENT)MENU]** key until “Setup Menu” appears.
2. Press the **[CALL(ENT)MENU]** key, then select “LED Setup” in the “Radio Setup” menu with the **[▼] / [▲]** key.
3. Press the **[CALL(ENT)MENU]** key.
4. Press the **[▼] / [▲]** key to select the LED to be changed and press the **[CALL(ENT)MENU]** key.
5. Press the **[▼] / [▲]** key to select “On” or “Off” for the Transmit LED, Receive LED and Water Hazard LED, or “Continuous”, “SOS”, “Blink1”, or “Blink2” for the Emergency LED.

Continuous: The **BUSY/TX** lamp glows continuously in white when the Emergency function is engaged

SOS: The **BUSY/TX** lamp flashes according to the “S.O.S” Morse Code (···-----) when the Emergency function is engaged. This is the default setting.

Blink1: The **BUSY/TX** lamp flashes rapidly when the Emergency function is engaged.

Blink2: The **BUSY/TX** lamp flashes slowly when the Emergency function is engaged.

6. Press the **[CALL(ENT)MENU]** key to store the selected setting.
7. To exit this menu and return to radio operation mode press the **[16/9]** key or press the **[CLR(WX)]** key several times.

```
-Setup Menu-
>Radio Setup
DSC Setup
GPS Setup
Compass Setup
Set>[ENT], Quit>[CLR]
```

```
-Radio Setup-
Key Beep
Weather Alert
CH Name
>LED Setup
Set>[ENT], Quit>[CLR]
```

```
-LED Setup-
>Transmit LED
Receive LED
Emergency LED
Water Hazard LED
Set>[ENT], Quit>[CLR]
```

```
-Transmit LED-
>On
Off
Set>[ENT], Quit>[CLR]
```

WATER STROBE NOTE

When the **HX851** is immersed in water the SOS strobe light will start blinking. This allows you to be able to see the radio that may have fallen overboard at night or when worn on a life vest aid in rescuing a person in the water.

9 DSC SETUP MENU

The **HX851**'s DSC Setup mode allows a number of the **HX851** DSC parameters to be custom-configured for your operating requirement.

INDIVIDUAL DIRECTORY - Refer to section 7.5.1

INDIVIDUAL REPLY - Refer to section 7.5.2

INDIVIDUAL ACK - Refer to section 7.6.1

INDIVIDUAL RINGER - Refer to section 7.5.3

GROUP DIRECTORY - Refer to section 7.7

POSITION REPLY - Refer to section 7.8.1

DSC BEEP

- Individual - Refer to section 7.5.3
- Group - Refer to section 7.7.2
- All Ships - Refer to section 7.4.
- Position Request - Refer to section 7.8.2
- Position Report - Refer to section 7.9.1
- Geographic - Refer to section 7.10.1

DSC Scan

When the radio is shipped from the factory it is programmed so CH70 (the DSC channel) is scanned at all times. This menu selection allows you to disable the DSC SCAN. However, turning off DSC SCAN will disable the radio from receiving DSC calls, (Individual Call, All Ships Call, Distress Call and Position Requests. If you want to use any of the functions the selection should be left ON.

1. Press and hold the **[CALL(ENT)MENU]** key until "Setup Menu" appears.
2. Press the **[▼]** key to select "DSC Setup" and press the **[CALL(ENT)MENU]** key.
3. Press the **[▼]** key to select "DSC Scan" and press the **[CALL(ENT)MENU]** key.
4. Press the **[▼]** or **[▲]** key to select "Off" and press the **[CALL(ENT)MENU]** key.
5. Press the **[16/9]** key to exit.

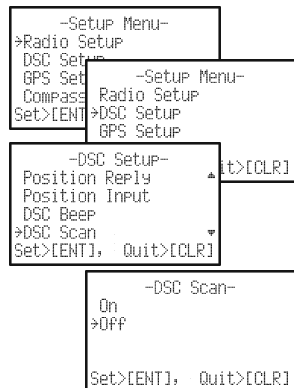

USER MMSI - Refer to section 7.2.2

10 GPS SETUP

The **HX851**'s "GPS Setup" mode allows a number of the **HX851** internal GPS unit's parameters to be custom-configured for your operating requirements.

10.1 UNIT POWER

This selection allows the internal GPS unit to be turned on or off to conserve battery power. The default setting is "On".

1. Press and hold the **[CALL(ENT)MENU]** key until "Setup Menu" appears.
2. Press the **[▼]** key to select "GPS Setup" menu.
3. Press the **[CALL(ENT)MENU]** key, then select "Unit Power" in the "GPS Setup" menu with the **[▼] / [▲]** key.
4. Press the **[CALL(ENT)MENU]** key.
5. Press the **[▼] / [▲]** key to select "On" or "Off".
6. Press the **[CALL(ENT)MENU]** key to store the selected level.
7. To exit this menu and return to radio operation mode press the **[16/9]** key or press the **[CLR(WX)]** key several times.

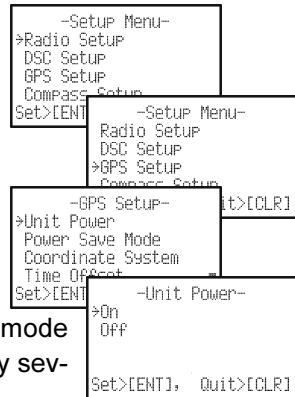

10.2 POWER SAVE MODE

This selection selects the Battery Save Mode for the internal GPS unit. The default setting for the Power Save Mode is "Level 1".

1. Press and hold the **[CALL(ENT)MENU]** key until "Setup Menu" appears.
2. Press the **[▼]** key to select "GPS Setup" menu.
3. Press the **[CALL(ENT)MENU]** key, then select "Power Save Mode" in the "GPS Setup" menu with the **[▼] / [▲]** key.
4. Press the **[CALL(ENT)MENU]** key.
5. Press the **[▼] / [▲]** key to select the desired level.
 - Off: GPS Signals are always being received.
 - Level 1: Activates the GPS receiver for 0.4 seconds every 5 seconds.
 - Level 2: Activates the GPS receiver for 50 seconds every 1 minute.
 - Level 3: Activates the GPS receiver for 50 seconds every 3 minutes.
 - Level 4: Activates the GPS receiver for 50 seconds every 5 minutes.
6. Press the **[CALL(ENT)MENU]** key to store the selected level.

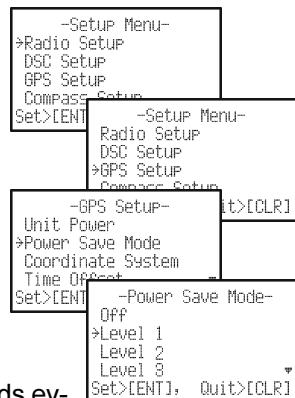

- To exit this menu and return to radio operation mode press the **[16/9]** key or press the **[CLR(WX)]** key several times.

NOTE

When Navigation or the GPS Status page is selected in the Radio Setup menu (refer to section **"8.1 DISPLAY"**), the GPS receiver will be automatically set to Level 1.

10.3 COORDINATE SYSTEM

This selection selects the Coordinate System to be shown on the **HX851** display. The default setting is "ddd mm.mmm".

- Press and hold the **[CALL(ENT)MENU]** key until "Setup Menu" appears.
- Press the **[▼]** key to select "GPS Setup" menu.
- Press the **[CALL(ENT)MENU]** key, then select "Coordinate System" in the "GPS Setup" menu with the **[▼] / [▲]** key.
- Press the **[CALL(ENT)MENU]** key.
- Press the **[▼] / [▲]** key to select the desired Coordinate System. The Coordinate System can be select to "ddd mm ss", "ddd mm.mm", or "ddd mm.mmm".
- Press the **[CALL(ENT)MENU]** key to store the selected system.
- To exit this menu and return to radio operation mode press the **[16/9]** key or press the **[CLR(WX)]** key several times.

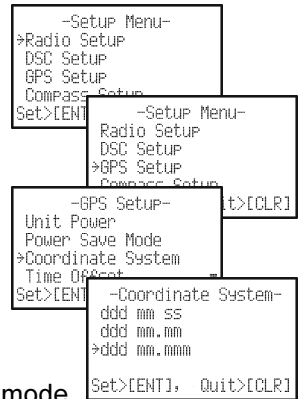

10.4 TIME OFFSET

Sets the time offset between local time and UTC shown on the display. The default setting is “UTC”.

1. Press and hold the [CALL(ENT)MENU] key until “Setup Menu” appears.
2. Press the [▼] key to select “GPS Setup” menu.
3. Press the [CALL(ENT)MENU] key, then select “Time Offset” in the “GPS Setup” menu with the [▼] / [▲] key.
4. Press the [CALL(ENT)MENU] key.
5. Press the [▼] / [▲] key to select time offset from UTC. See illustration below to find your offset time from UTC. If “00:00” is assigned, the time is the same as UTC (Universal Time Coordinated or GMT Greenwich Mean Time).
6. Press the [CALL(ENT)MENU] key to store the time offset.
7. To exit this menu and return to radio operation mode press the [16/9] key or press the [CLR(WX)] key several times.

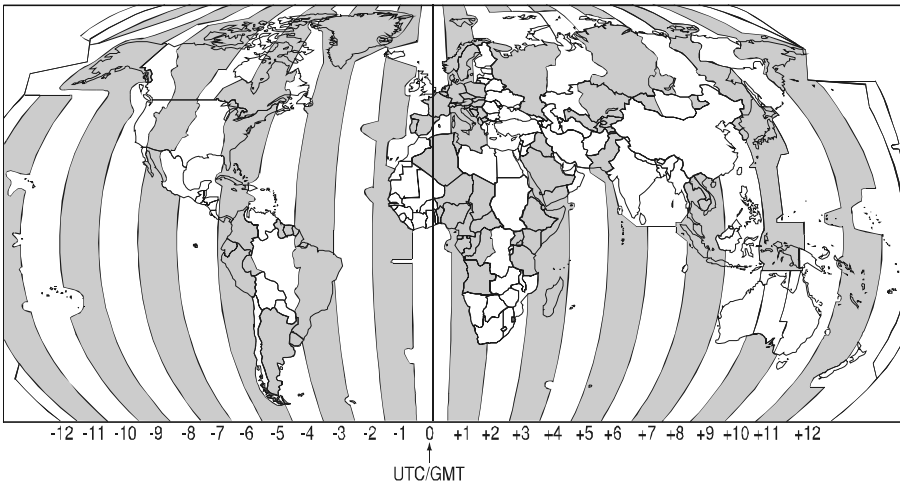
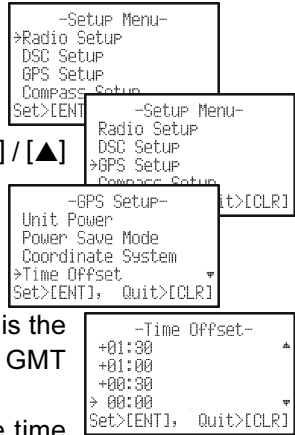

OFFSET TIME TABLE

10.5 TIME DISPLAY

Allows the time shown on the display to be shown in local (with offset inputted in section “9.4 TIME OFFSET”) or UTC time. The default setting is “UTC”.

1. Press and hold the [CALL(ENT)MENU] key until “Setup Menu” appears.
2. Press the [▼] key to select “GPS Setup” menu.
3. Press the [CALL(ENT)MENU] key, then select “Time Display” in the “GPS Setup” menu with the [▼] / [▲] key.
4. Press the [CALL(ENT)MENU] key.
5. Press the [▼] / [▲] key to select “UTC” or “Local”.
6. Press the [CALL(ENT)MENU] key to store the selected setting.
7. To exit this menu and return to radio operation mode press the [16/9] key or press the [CLR(WX)] key several times.

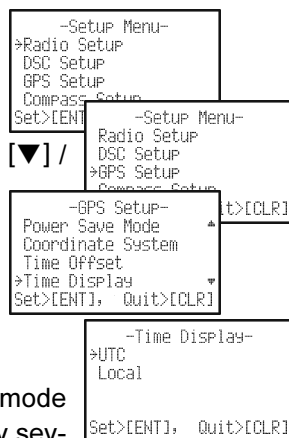

10.6 TIME FORMAT

Allows the time shown on the display to be shown in 12 hours or 24 hours time formats. The default setting is “12 hours”.

1. Press and hold the [CALL(ENT)MENU] key until “Setup Menu” appears.
2. Press the [▼] key to select “GPS Setup” menu.
3. Press the [CALL(ENT)MENU] key, then select “Time Format” in the “GPS Setup” menu with the [▼] / [▲] key.
4. Press the [CALL(ENT)MENU] key.
5. Press the [▼] / [▲] key to select “24H” or “12H”.
6. Press the [CALL(ENT)MENU] key to store the selected setting.
7. To exit this menu and return to radio operation mode press the [16/9] key or press the [CLR(WX)] key several times.

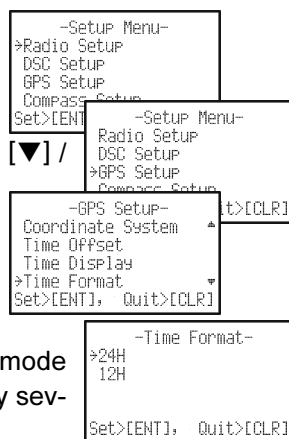

10.7 SOG UNIT

Allows the SOG shown on the NAV display to be shown in Kts (knot), MPH (mile/hour) or KPH (kilo-meter/hour). The default setting is “Kts: Knots”.

1. Press and hold the [CALL(ENT)MENU] key until “Setup Menu” appears.
2. Press the [▼] key to select “GPS Setup” menu.
3. Press the [CALL(ENT)MENU] key, then select “SOG Unit” in the “GPS Setup” menu with the [▼] / [▲] key.
4. Press the [CALL(ENT)MENU] key.
5. Press the [▼] / [▲] key to select the desired unit.
6. Press the [CALL(ENT)MENU] key to store the selected setting.
7. To exit this menu and return to radio operation mode press the [16/9] key or press the [CLR(WX)] key several times.

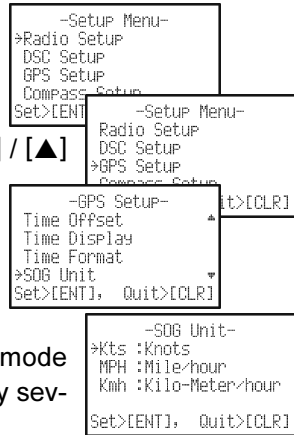

10.8 POS DATA PRIORITY

This menu item allows the **HX851** to:

- a. use the internal GPS to compute and display position information (default setting)
 - b. use the NMEA output of an external GPS Chart Plotter to input position information into the **HX851**. This is a useful feature when the **HX851** is located in an area where GPS reception is limited and this selection increases battery life of the **HX851** between charges.
1. Press and hold the [CALL(ENT)MENU] key until “Setup Menu” appears.
 2. Press the [▼] key to select “GPS Setup” menu.
 3. Press the [CALL(ENT)MENU] key, then select “POS DATA Priority” in the “GPS Setup” menu with the [▼] / [▲] key.
 4. Press the [CALL(ENT)MENU] key.
 5. Press the [▼] / [▲] key to select “Internal GPS” or “External I/O port”.
 6. Press the [CALL(ENT)MENU] key to store the selected setting.
 7. To exit this menu and return to radio operation mode press the [16/9] key or press the [CLR(WX)] key several times.

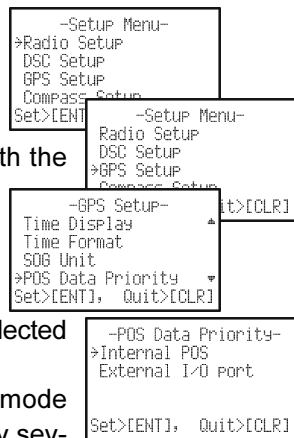

NOTE

If NMEA 0183 from an External GPS Chart plotter is selected and the **HX851** is moved outside, the Pos Data Priority must be changed to Internal GPS to compute fix.

10.9 NMEA OUTPUT

This menu item is used to setup the NMEA output sentences of the **HX851**. By default, all the NMEA sentences are turned off.

1. Press and hold the [**CALL(ENT)MENU**] key until "Setup Menu" appears.
2. Press the [**▼**] key to select "GPS Setup" menu.
3. Press the [**CALL(ENT)MENU**] key, then select "NMEA Output" in the "GPS Setup" menu with the [**▼**] / [**▲**] key.
4. Press the [**CALL(ENT)MENU**] key.
5. Press the [**▼**] / [**▲**] key to select the desired sentence. Available sentences are "GLL", "GAA", "GSA", "GSU", and "RMC".
6. Press the [**CALL(ENT)MENU**] key, then press the [**▼**] / [**▲**] key to select "On" or "Off".
7. Press the [**CALL(ENT)MENU**] key to store the selected setting.
8. To exit this menu and return to radio operation mode press the [**16/9**] key or press the [**CLR(WX)**] key several times.

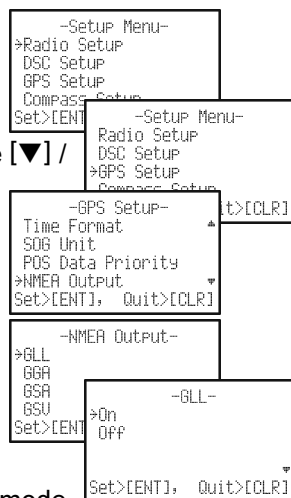

10.10 ALTITUDE UNIT

Allows selection of the units of measure of the altitude. The default setting is "ft".

1. Press and hold the [**CALL(ENT)MENU**] key until "Setup Menu" appears.
2. Press the [**▼**] key to select "GPS Setup" menu.
3. Press the [**CALL(ENT)MENU**] key, then select "Altitude Unit" in the "GPS Setup" menu with the [**▼**] / [**▲**] key.
4. Press the [**CALL(ENT)MENU**] key.
5. Press the [**▼**] / [**▲**] key to select "m" or "ft".
6. Press the [**CALL(ENT)MENU**] key to store the selected setting.
7. To exit this menu and return to radio operation mode press the [**16/9**] key or press the [**CLR(WX)**] key several times.

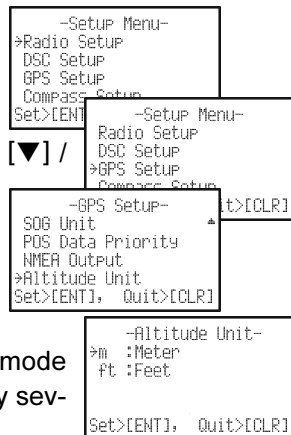

11 COMPASS SETUP

This function allows you to select the Compass display to be orientated in Course Up or North Up.

1. Press and hold the [CALL(ENT)MENU] key until "Setup Menu" appears.
2. Press the [▼] key to select "Compass Setup" menu.
3. Press the [CALL(ENT)MENU] key to display the "Direction".
4. Press the [CALL(ENT)MENU] key again.
5. Press the [▼] / [▲] key to select to select "North Up" or "Course Up".
6. Press the [CALL(ENT)MENU] key to store the selected setting.
7. To exit this menu and return to radio operation mode press the [16/9] key or press the [CLR(WX)] key several times.

```
-Setup Menu-
>Radio Setup
DSC Setup
GPS Setup
Compass
Set>[ENT]
```

```
-Setup Menu-
Radio Setup
DSC Setup
GPS Setup
>Compass Setup
Set>[ENT], Quit>[CLR]
```

```
-Compass Setup-
>Direction

Set>[ENT], Quit>[CLR]
```

```
-Direction-
>North Up
Course Up

Set>[ENT], Quit>[CLR]
```

12 WAYPOINTS

The **HX851** is capable of storing up to 200 waypoints and navigating to them using the compass page.

In addition DSC distress calls with position or a position received from another DSC radio using DSC polling can be navigated to.

12.1 STORING WAYPOINTS

1. Press and hold down the **[CALL(ENT)MENU]** key until "Setup Menu" appears.
2. Press the **[▼]** key to select "Waypoint Setup" menu.
3. Press the **[CALL(ENT)MENU]** key, then select "Waypoint Directory" with the **[▼] / [▲]** key.
4. Press the **[CALL(ENT)MENU]** key.
5. Select "Add" with the **[▼] / [▲]** key, press the **[CALL(ENT)MENU]** key.
6. Press the **[▼] / [▲]** key to select the first letter of the Waypoint Name you want to reference in the directory.
7. Press the **[CALL(ENT)MENU]** key to store the first letter and to move to the second letter in the name.
8. Repeat step 6 and 7 until the name is shown. Press the **[CALL(ENT)MENU]** key to skip a letter if needed.
9. Press the **[▼] / [▲]** key to skip the ID: entry and to the first digit of the latitude.
10. Enter the coordinates of the waypoint POSITION, by pressing the **[▼] / [▲]** key to select the first digit in the Latitude.
11. Press the **[CALL(ENT)MENU]** key to store the first number and to move to the second number in the position.
12. Repeat step 10 and 11 until the latitude is shown include N or S in the last digit.
13. Press the **[CALL(ENT)MENU]** key until the first digit of the Longitude is blinking.
14. Press the **[▼] / [▲]** key to select the first digit in the Longitude.
15. Press the **[CALL(ENT)MENU]** key to store the first number and to move to the second number in the position.

```
-Setup Menu-
>Radio Setup
DSC Setup
GPS Setup
Compass
Set>[ENT]

-Setup Menu-
DSC Setup
GPS Setup
Compass Setup
>Waypoint Setup
Set>[ENT], Quit>[CLR]
```

```
-Waypoint Setup-
>Waypoint Directory
Distance Unit
Display Range
Set>[ENT]

-Waypoint Directory-
>Add
Edit
Delete
```

```
-Waypoint Input-
WPT Name:_
ID:-----
Position: --°--'---
Set>[ENT], Quit>[CLR]
```

```
-Waypoint Input-
WPT Name:Fishing PT
ID:-----
Position: 3°--'---
Set>[ENT], Quit>[CLR]
```

```
-Waypoint Input-
WPT Name:Fishing PT
ID:-----
Position: 33°37.125N
Set>[ENT], Quit>[CLR]
```

```
-Waypoint Input-
WPT Name:Fishing PT
ID:-----
Position: 33°37.125N
1--'---
Set>[ENT], Quit>[CLR]
```

16. Repeat step 14 and 15 until the Latitude is shown include E or W in the last digit.
17. If a mistake was made entering in the MMSI number repeat pressing the **[H/L (On)]** key until the wrong number is selected, then press the **[▼] / [▲]** key to correct the entry.
18. After all information is entered, press and hold the **[CALL(ENT)MENU]** key to store the waypoint into memory.

```

-Waypoint Input-
WPT Name:Fishing PT
ID:-----
Position: 33°37.125N
          118°09.587W
Set>[ENT], Quit>[CLR]

```

12.2 EDITING A WAYPOINT

This function allows a previously entered waypoint to be edited.

1. Press and hold down the **[CALL(ENT)MENU]** key until “Setup Menu” appears.
2. Press the **[▼]** key to select “Waypoint Setup” menu.
3. Press the **[CALL(ENT)MENU]** key, then select “Waypoint Directory” with the **[▼] / [▲]** key.
4. Press the **[CALL(ENT)MENU]** key.
5. Select “Edit” with the **[▼] / [▲]** key, then press the **[CALL(ENT)MENU]** key.
6. Show the waypoint Input display.
7. Press the **[CALL(ENT)MENU]** key repeatedly until the number or letter is selected that is to be changed.
8. Press the **[▼] / [▲]** key to change the letter or number.
9. Repeat step 7 and 8 until the waypoint is updated.
10. Press and hold the **[CALL(ENT)MENU]** key to store the edited waypoint into memory.

```

-Setup Menu-
→Radio Setup
DSC Setup
GPS Setup
Compass
Set>[ENT]

```

```

-Setup Menu-
DSC Setup
GPS Setup
Compass Setup
→Waypoint Setup
Set>[ENT], Quit>[CLR]

```

```

-Waypoint Setup-
→Waypoint Directory
Distance Unit
Display Range
Set>[ENT]

```

```

-Waypoint Directory-
Add
→Edit
Delete

```

```

-Waypoint Directory-
Swim Point
→Fishing PT
Port
Set>[ENT]

```

```

-Waypoint Input-
WPT Name:Fishing PT
ID:-----
Position: 33°37.125N
          118°09.587W
Set>[ENT], Quit>[CLR]

```

12.3 DELETING A WAYPOINT

1. Press and hold down the [CALL(ENT)MENU] key until “Setup Menu” appears.
2. Press the [▼] key to select “Waypoint Setup” menu.
3. Press the [CALL(ENT)MENU] key, then select “Waypoint Directory” with the [▼] / [▲] key.
4. Press the [CALL(ENT)MENU] key
5. Select “Delete” with the [▼] / [▲] key, then press the [CALL(ENT)MENU] key.
6. Press the [▼] / [▲] key to select the waypoint to be deleted.
7. Press and hold the [CALL(ENT)MENU] key until the radio beeps and the waypoint directory is removed from the display.

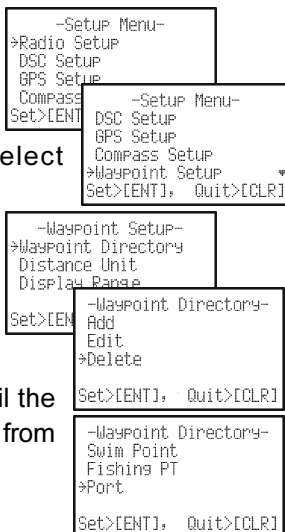

12.4 SAVING A DSC POSITION CALL AS A WAYPOINT

When a position is received from another DSC radio the **HX851** allows the position to be saved as a waypoint.

1. After a position has been received, press the [CALL(ENT)MENU] key.
2. The first digit in the WPT Name will be flashing, Press the [▼] / [▲] key to the first letter of the name you want to input.
3. Press the [CALL(ENT)MENU] key, then press the [▼] / [▲] key to select the second letter in the name.
4. Repeat step 3 until the name is shown.
5. Press and hold the [CALL(ENT)MENU] key until the radio beeps.
6. To stop navigating to waypoint:
 - 1) Press and hold down the [CALL(ENT)MENU] key until “Setup Menu” appears.
 - 2) Press the [▼] / [▲] key to select “Radio Setup”.
 - 3) Press the [CALL(ENT)MENU] key, then select “Display” with the [▼] / [▲] key.
 - 4) Press the [CALL(ENT)MENU] key, and select “Radio”, “Position”, “Navigation” or “Compass” other than “Waypoint”, and press the [CALL(ENT)MENU] key.

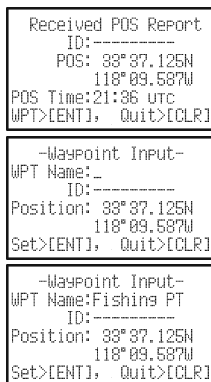

12.5 NAVIGATING TO A SAVED WAYPOINT

1. Press and hold down the [CALL(ENT)MENU] key until “Setup Menu” appears.
2. Press the [▼] / [▲] key to select “Radio Setup”.
3. Press the [CALL(ENT)MENU] key, then select “Display” with the [▼] / [▲] key.
4. Press the [CALL(ENT)MENU] key, and select “Waypoint” with the [▼] / [▲] key.
5. Press the [CALL(ENT)MENU] key.
6. Select the waypoint name and press the [CALL(ENT)MENU] key to show the waypoint data display.
7. Press the [CALL(ENT)MENU] key to start navigating the waypoint and show the Waypoint Nav display.

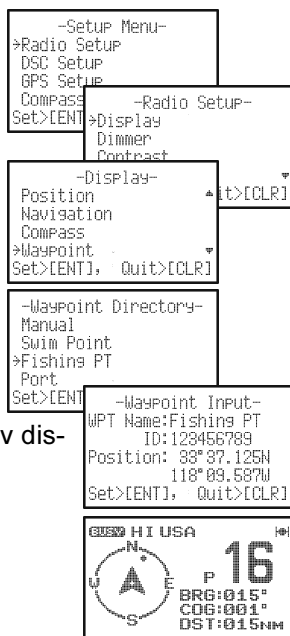

12.6 STOP NAVIGATING TO A WAYPOINT

To stop navigating to a waypoint, the radio must be switched to Normal Mode with the following procedure.

1. Press and hold down the [CALL(ENT)MENU] key until “Setup Menu” appears.
2. Press the [▼] / [▲] key to select “Radio Setup”.
3. Press the [CALL(ENT)MENU] key, then select “Display” with the [▼] / [▲] key.
4. Press the [CALL(ENT)MENU] key, and select “Radio”, “Position”, “Navigation” or “Compass” other than “Waypoint”, and press the [CALL(ENT)MENU] key.



12.7 WAYPOINT SETUP

12.7.1 DISTANCE UNIT

Allows Waypoint display to be shown in “Nautical Mile”, “Statue Mile” or “Kilo-Meter” for distance.

1. Press and hold down the [CALL(ENT)MENU] key until “Setup Menu” appears.
2. Press the [▼] / [▲] key to select “Waypoint Setup”.
3. Press the [CALL(ENT)MENU] key, then select “Distance Unit” with the [▼] / [▲] key.
4. Press the [CALL(ENT)MENU] key.
5. Press the [▼] / [▲] key to select desired unit. Available selections are NM (Nautical Mile), SM (Mile) or KM (Kilo-Meter) for distance.
6. Press the [CALL(ENT)MENU] key to store the selected setting.
7. To exit this menu and return to radio operation mode press the [16/9] key or press the [CLR(WX)] key several times.

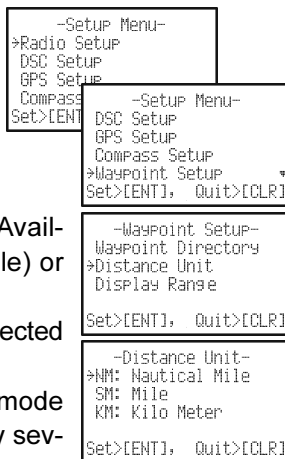

12.7.2 DISPLAY RANGE

This menu item allows setting of the range rings on the display. The default setting is “Auto”.

1. Press and hold down the [CALL(ENT)MENU] key until “Setup Menu” appears.
2. Press the [▼] / [▲] key to select “Waypoint Setup”.
3. Press the [CALL(ENT)MENU] key, then select “Display Range” with the [▼] / [▲] key.
4. Press the [CALL(ENT)MENU] key.
5. Press the [▼] / [▲] key to select desired Range. Available selections are Auto (Auto change), 2, 4, 8, 10, 15, 20, 30, 40 or 50.
6. Press the [CALL(ENT)MENU] key to store the selected setting.
7. To exit this menu and return to radio operation mode press the [16/9] key or press the [CLR(WX)] key several times.

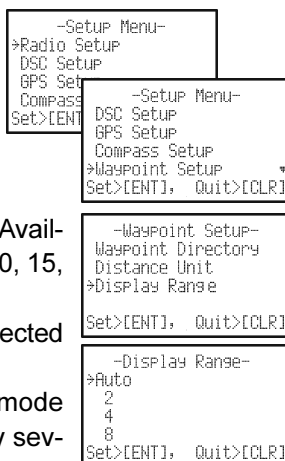

13 MAINTENANCE

13.1 GENERAL

The inherent quality of the solid-state components in STANDARD HORIZON radios will provide many years of continuous use. Take the following precautions to prevent damage to the radio.

- To prevent corrosion of electrical contacts and keep the water resistance, keep the microphone connected or the jack covered at all times.
- Never key the transmitter unless an antenna or suitable dummy load is connected to the antenna receptacle.
- Use only STANDARD HORIZON-approved accessories and replacement parts.

In the unlikely event of serious problems, please contact your Dealer or our repair facility. Address and phone numbers for this facility, as well as warranty information, are contained in section “**15 WARRANTY.**”

13.2 REPLACEMENT PARTS

Occasionally an owner needs a replacement part. These can be ordered from our Parts Department by writing or calling:

Marine Division of Vertex Standard

US Headquarters

10900 Walker Street, Cypress, CA 90630, U.S.A.

Telephone (714) 827-7600

Commonly requested parts, and their part numbers are listed below.

- **CD-38** Charger Cradle: AAF93X001
- **CAT460** Antenna: Q3000176
- **Belt Clip** (CLIP-19): CP9173001
- **DISTRESS** Cover Cap: RA0995600
- **MIC/SP** Plastic Cap: RA1087000
- **MIC/SP** Cap O-Ring: RA046760A
- **MIC/SP** Rubber: RA1030500

13.3 FACTORY SERVICE

In the unlikely event that the radio fails to perform or needs servicing, please contact the following:

Standard Horizon





Attention Marine Repair Department

10900 Walker Street, Cypress, CA 90630

Telephone (800) 366-4566

An “RA” Return Authorization number is not necessary to send a product in for service. Include a brief note describing the problem along with your name, return address, phone number, and proof of purchase.

13.4 TROUBLESHOOTING CHART

SYMPTOM	PROBABLE CAUSE	REMEDY
The [SCAN(DW)] key does not start the scan.	No channels memorized.	Use the [MEM] key to enter desired channels into the transceiver's memory.
	Squelch is not adjusted.	Press the [SQL] key and press the [▲] key until the “  ” icon disappears. Further adjustment of the squelch control may eliminate incoming signals.
The USA/INTL/CAN modes do not function.	Proper operation not followed.	HOLD down the [16/9] key and press the [CLR(WX)] key.
Press and holding the [SQL] switch does not eliminate background noise.	Low battery.	Charge battery. Refer to section 4 of this manual.
	Audio volume level is too low.	Press the [VOL] key and press the [▲] key several times.
Cannot change any function.	Key Lock is “on”.	Turn the Key Lock to “off”. Refer to section 5, [H/L()] key.
Key Lock does not function.	Proper operation not followed.	Hold down the [H/L()] key for 2 seconds.
Cannot receive a DSC call.	Squelch is open.	Press the [SQL] key and press the [▲] key until the “  ” icon disappears.
	DSC SCAN is “off”.	Turn the DSC SCAN to “on” in the DSC Setup menu.
Cannot transmit a DSC Call.	MMSI number is not programmed.	Program the MMSI number. Refer to section 7.2.2 of this manual.
Can not fix the GPS satellites.	Internal GPS receiver is “off”.	Internal GPS receiver is “on”. Refer to section 9.1 of this manual.
	Poor location for GPS satellite reception.	Move to a less obstructed position.
Indicator does not light when charging a battery.	Defective battery FNB-V99LI.	Contact Standard Horizon dealer.

14 CHANNEL ASSIGNMENTS

Tables on the following columns list the VHF Marine Channel assignments for U.S.A. and International use. Below are listed some data about the charts.

1. VTS. Where indicated, these channels are part of the U.S. Coast Guard's **Vessel Traffic System**.
2. Alpha channel numbers, that is, channel numbers followed by the letter A (such as Channel 07**A**) are **simplex** channels on the U.S.A. or Canadian channel assignments whose counterparts in the International assignments are **duplex** channels. International channels do not use "alpha" numbers. If you call the Coast Guard on Channel 16, they will sometimes ask you to "**go to channel 22 Alpha**." This is a channel assigned to U.S.A., and Canadian Coast Guards for handling distress and other calls. If your radio is set for **International** operation you will go to Channel 22 instead of 22**A**, and will not be able to communicate with the Coast Guard. To use Channel 22**A**, your radio must be set for **USA** or **Canada** operation, usually by a U/I/C (USA/International/Canada) control or combination of controls. Channel 22 (without an "A") is an **International** duplex channel for port operations. Some radios indicate an "A" adjacent to the alpha channels on the display; on others "alpha" is not indicated but the proper channel is selected based on the U/I/C setting.
3. Bridge-to-Bridge channels (for example, Channel 13) are for use by bridge operators on intercoastal waterways and rivers. It is also used by marine vessels in the vicinity of these bridges for navigation and for communicating with the bridge operators. Note that a limit of 1 Watt is specified for these channels. See page 14 for additional information.
4. The **S/D** column on the chart indicates either S (simplex) or D (duplex). **Simplex** means transmitting and receiving on the same frequency. Only one party at a time can talk, unlike a telephone. Be sure to say "**over**" and release your microphone push-to-talk switch at the end of each transmission. **Duplex** operation involves the use of one frequency for transmitting and a separate frequency for receiving. On channels specified as duplex on the charts, correct mode of operation is established automatically by your radio when you select a channel; you cannot change the mode. And you still must release the push-to-talk switch after each transmission in order to listen to the radio.
5. Channels normally used by recreational boaters are those that include the term "non-commercial" in the **Channel Use** column of the chart. Some of these are shared with other users and some are used only in certain geographic regions.

6. Marine vessels equipped with VHF radios are required to monitor Channel 16.

VHF MARINE CHANNEL CHART								
CH	U	C	I	S/D	TX	RX	CHANNEL USE	
01		X	X	D	156.050	160.650	Public Correspondence (Marine Operator)	
01A	X			S	156.050		Port Operation and Commercial. VTS in selected areas	
02		X	X	D	156.100	160.700	Public Correspondence (Marine Operator)	
03		X	X	D	156.150	160.750	Public Correspondence (Marine Operator)	
03A	X			S	156.150		U.S. Government Only, Coast Guard	
04			X	D	156.200	160.800	Public Correspondence (Marine Operator), Port operation, ship movement	
04A		X		S	156.200		Pacific coast: Coast Guard, East Coast: Commercial fishing	
05			X	D	156.250	160.850	Public Correspondence (Marine Operator), Port operation, ship movement	
05A	X	X		S	156.250		Port operation. VTS in Seattle	
06	X	X	X	S	156.300		Inter-ship Safety	
07			X	D	156.350	160.950	Public Correspondence (Marine Operator), Port operation, ship movement	
07A	X	X		S	156.350		Commercial	
08	X	X	X	S	156.400		Commercial (Inter-ship only)	
09	X	X	X	S	156.450		Boater Calling channel, Commercial & Non-commercial (Recreational)	
10	X	X	X	S	156.500		Commercial	
11	X	X	X	S	156.550		Commercial. VTS in selected areas.	
12	X	X	X	S	156.600		Port operation. VTS in selected areas.	
13	X	X	X	S	156.650		Inter-ship Navigation Safety (Bridge-to-bridge)	
14	X	X	X	S	156.700		Port operation. VTS in selected areas.	
15	X			S	--	156.750	Environmental (Receive only)	
15		X	X	S	156.750		Commercial, non-commercial, ship movement (1 W)	
16	X	X	X	S	156.800		International Distress, Safety and Calling	
17	X	X	X	S	156.850		State Controlled (1 W)	
18			X	D	156.900	161.500	Port operation, ship movement	
18A	X	X		S	156.900		Commercial	
19			X	D	156.950	161.550	Port operation, ship movement	
19A	X			S	156.950		US: Commercial	
19A		X		S	156.950		Coast Guard	
20	X	X	X	D	157.000	161.600	Canadian Coast Guard Only, International: port operations and shipment	
20A	X			S	157.000		Port operation	
21			X	D	157.050	161.650	Port operation, ship movement	
21A	X	X		S	157.050		U.S. Government Only, Canadian Coast Guard	
22			X	D	157.100	161.700	Port operation, ship movement	
22A	X	X		S	157.100		US and Canadian Coast Guard Liaison and Maritime Safety Information Broadcasts announced on channel 16	
23		X	X	D	157.150	161.750	Public Correspondence (Marine Operator)	
23A	X			S	157.150		U.S. Government Only	
24	X	X	X	D	157.200	161.800	Public Correspondence (Marine Operator)	
25	X	X	X	D	157.250	161.850	Public Correspondence (Marine Operator)	
26	X	X	X	D	157.300	161.900	Public Correspondence (Marine Operator)	
27	X	X	X	D	157.350	161.950	Public Correspondence (Marine Operator)	
28	X	X	X	D	157.400	162.000	Public Correspondence (Marine Operator)	

VHF MARINE CHANNEL CHART							
CH	U	C	I	S/D	TX	RX	CHANNEL USE
60		X	X	D	156.025	160.625	Public Correspondence (Marine Operator)
61			X	D	156.075	160.675	Public Correspondence (Marine Operator), Port operation, ship movement
61A	X	X		S	156.075		Public Coast: Coast Guard; East Coast: commercial fishing only
62			X	D	156.125	160.725	Public Correspondence (Marine Operator), Port operation, ship movement
62A		X		S	156.125		Public Coast: Coast Guard; East Coast: commercial fishing only
63			X	D	156.175	160.775	Public Correspondence (Marine Operator), Port operation, ship movement
63A	X	X		S	156.175		Port Operation and Commercial. VTS in selected areas.
64		X	X	D	156.225	160.825	Public Correspondence (Marine Operator), Port operation, ship movement
64A	X	X		S	156.225		Public Correspondence (Marine Operator), Port operation, ship movement
65			X	D	156.275	160.875	Public Correspondence (Marine Operator), Port operation, ship movement
65A	X	X		S	156.275		Port Operations
66			X	D	156.325	160.925	Public Correspondence (Marine Operator), Port operation, ship movement
66A	X	X		S	156.325		Port Operations
67	X	X	X	S	156.375		US: Commercial. Used for Bridge-to-bridge com- muni-cations in lower Mississippi River. Inter-ship only, Canada: Commercial fishing, S&R
68	X	X	X	S	156.425		Non-commercial (Recreational)
69	X	X	X	S	156.475		US: Non-commercial (Recreational), Canada: Commercial fishing only, International: Inter-ship, Port operations and Ship movement
70	X	X	X	S	156.525		Digital selective calling (voice communications not allowed)
71	X	X	X	S	156.575		US, Canada: Non-commercial (Recreational), International: Port operations and Ship movement
72	X	X	X	S	156.625		Non-commercial (Inter-ship only)
73	X	X	X	S	156.675		US: Port Operations, Canada: Commercial fish ing only, International: Inter-ship, Port operations and Ship movement
74	X	X	X	S	156.725		US: Port Operations, Canada: Commercial fishing only, International: Inter-ship, Port operations and Ship movement
75	X	X	X	S	156.775		Port Operations (Inter-ship only) (1W)
76	X	X	X	S	156.825		Port Operations (Inter-ship only) (1W)
77	X	X		S	156.875		Port Operations (Inter-ship only) (1W)
77			X	S	156.875		Port Operations (Inter-ship only)
78			X	D	156.925	161.525	Public Correspondence (Marine Operator), Port operation, ship-movement
78A	X	X		S	156.925		Non-commercial (Recreational)
79			X	D	156.975	161.575	Port operation and Ship movement
79A	X	X		S	156.975		Commercial

VHF MARINE CHANNEL CHART							
CH	U	C	I	S/D	TX	RX	CHANNEL USE
80			X	D	157.025	161.625	Port operation, ship movement
80A	X	X		S	157.025		Commercial
81			X	D	157.075	161.675	Port operation, ship movement
81A	X			S	157.075		U.S. Government Only - Environmental protection operations.
81A		X		S	157.075		Canadian Coast Guard Only
82			X	D	157.125	161.725	Public Correspondence (Marine Operator), Port operation, ship movement
82A	X	X		S	157.125		U.S. Government Only, Canadian Coast Guard Only
83		X		D	157.175	161.775	Canadian Coast Guard Only
83			X	D	157.175	161.775	Public Correspondence (Marine Operator)
83A	X	X		S	157.175		U.S. Government Only, Canadian Coast Guard Only
84	X	X	X	D	157.225	161.825	Public Correspondence (Marine Operator)
85	X	X	X	D	157.275	161.875	Public Correspondence (Marine Operator)
86	X	X	X	D	157.325	161.925	Public Correspondence (Marine Operator)
87		X	X	S	157.375		Port operation, ship movement
87A	X			S	157.375		Public Correspondence (Marine Operator)
88		X	X	S	157.425		Port operation, ship movement
88A	X			S	157.425		Commercial, Inter-ship Only
WX01	X	X	X	D	---	162.550	Weather (receive only)
WX02	X	X	X	D	---	162.400	Weather (receive only)
WX03	X	X	X	D	---	162.475	Weather (receive only)
WX04	X	X	X	D	---	162.425	Weather (receive only)
WX05	X	X	X	D	---	162.450	Weather (receive only)
WX06	X	X	X	D	---	162.500	Weather (receive only)
WX07	X	X	X	D	---	162.525	Weather (receive only)
WX08	X	X	X	D	---	161.650	Weather (receive only)
WX09	X	X	X	D	---	161.775	Weather (receive only)
WX10	X	X	X	D	---	163.275	Weather (receive only)

NOTE: Simplex channels, 3A, 21A, 23A, 61A, 64A, 81A, 82A and 83A CANNOT be lawfully used by the general public in U.S.A. waters.

Channel designator	Carrier frequency (MHz)		Points of communication (Intership and between coast and ship unless otherwise indicated)	
	Ship transmit	Coast transmit		
Port Operations				
01A ¹	156.050	156.050	Intership only.	
63A ¹	156.175	156.175		
05 ²	156.250	156.250		
65A	156.275	156.275		
66A	156.325	156.325		
12 ³	156.600	156.600		
73	156.675	156.675		
14 ³	156.700	156.700		
74	156.725	156.725		
77 ⁴	156.875			
20	157.000	161.600		
20A ¹²	157.000			
Navigational (Bridge-to-Bridge)⁵				
13 ⁸	156.650	156.650		
67 ⁷	156.375	156.375		
Commercial				
01A ¹	156.050	156.050	Intership only. Do.	
63A ¹	156.175	156.175		
07A	156.350	156.350		
67 ⁷	156.375			
08	156.400		
09	156.450	156.450		
10	156.500	156.500		
11 ³	156.550	156.550		
18A	156.900	156.900		
19A	156.950	156.950		
79A	156.975	156.975		
80A	157.025	157.025		
88A ⁶	157.425		
72 ¹⁴	156.625		
Digital Selective Calling				
70 ¹⁵	156.525	156.525		

Channel designator	Carrier frequency (MHz)		Points of communication (Intership and between coast and ship unless otherwise indicated)	
	Ship transmit	Coast transmit		
Noncommercial				
68 ¹⁷	156.425	156.425	Intership only. Great Lakes only. Do. Internship only.	
09 ¹⁶	156.450	156.450		
69	156.475	156.475		
71	156.575	156.575		
72	156.625		
78A	156.925	156.925		
79A	156.975	156.975		
80A	157.025	157.025		
67 ¹⁴	156.375		
Distress, Safety and Calling				
16	156.800	156.800		EPRIB
Intership Safety				
06	156.300		a. Intership, or b. For SAR: Ship and aircraft for the U.S. Coast Guard.
Environmental				
15 ¹³	156.750	Coast to ship only.	
Maritime Control				
17 ^{9,10}	156.850	156.850		
Liaison, U.S. Coast Guard				
22A ¹¹	157.100	157.100	Ship, aircraft, and coast stations of the U.S. Coast Guard and at Lake Mead, Nev., ship and coast stations of the National Park Service, U.S. Department of the Interior.	

- 1: 156.050 MHz and 156.175 MHz are available for port operations and commercial communications purposes when used only within the U.S. Coast Guard designated Vessel Traffic Services (VTS) area of New Orleans, on the lower Mississippi River from the various pass entrances in the Gulf of Mexico to Devil's Swamp Light at River Mile 242.4 above head of passes near Baton Rouge.
- 2: 156.250 MHz is available for port operations communications use only within the U.S. Coast Guard designated VTS radio protection areas of New Orleans and Houston described in Sec. 80.383. 156.250 MHz is available for intership port operations communications used only within the area of Los Angeles and Long Beach harbors, within a 25-nautical mile radius of Point Fermin, California.
- 3: 156.550 MHz, 156.600 MHz and 156.700 MHz are available in the U.S. Coast Guard designated port areas only for VTS communications and in the Great Lakes available primarily for communications relating to the movement of ships in sectors designated by the St. Lawrence Seaway Development Corporation or the U.S. Coast Guard. The use of these frequencies outside VTS and ship movement sector protected areas is permitted provided they cause no interference to VTS and ship movement communications in their respective designated sectors.

- 4: Use of 156.875 MHz is limited to communications with pilots regarding the movement and docking of ships. Normal output power must not exceed 1 watt.
- 5: 156.375 MHz and 156.650 MHz are available primarily for intership navigational communications. These frequencies are available between coast and ship on a secondary basis when used on or in the vicinity of locks or drawbridges. Normal output power must not exceed 1 watt. Maximum output power must not exceed 10 watts for coast stations or 25 watts for ship stations.
- 6: On the Great Lakes, in addition to bridge-to-bridge communications, 156.650 MHz is available for vessel control purposes in established vessel traffic systems. 156.650 MHz is not available for use in the Mississippi River from South Pass Lighted Whistle Buoy "2" and Southwest Pass entrance Mid-channel Lighted Whistle Buoy to mile 242.4 above Head of Passes near Baton Rouge. Additionally it is not available for use in the Mississippi River-Gulf Outlet, the Mississippi River-Gulf Outlet Canal, and the Inner Harbor Navigational Canal, except to aid the transition from these areas.
- 7: Use of 156.375 MHz is available for navigational communications only in the Mississippi River from South Pass Lighted Whistle Buoy "2" and Southwest Pass entrance Mid-channel Lighted Whistle Buoy to mile 242.4 above head of Passes near Baton Rouge, and in addition over the full length of the Mississippi River-Gulf Outlet Canal from entrance to its junction with the Inner Harbor Navigation Canal, and over the full length of the Inner Harbor Navigation Canal from its junction with the Mississippi River to its entry to Lake Pontchartrain at the New Seabrook vehicular bridge.
- 8: Within 120 km (75 miles) of the United States/Canada border, in the area of the Puget Sound and the Strait of Juan de Fuca and its approaches, 157.425 MHz is half of the duplex pair designated as Channel 88. In this area, Channel 88 is available to ship stations for communications with public coast stations only. More than 120 km (75 miles) from the United States/Canada border in the area of the Puget Sound and the Strait of Juan de Fuca, its approaches, the Great Lakes, and the St. Lawrence Seaway, 157.425 MHz is available for intership and commercial communications. Outside Puget Sound area and its approaches and the Great Lakes, 157.425 MHz is also available for communications between commercial fishing vessels and associated aircraft while engaged in commercial fishing activities.
- 9: When the frequency 156.850 MHz is authorized, it may be used additionally for search and rescue training exercises conducted by state or local governments.
- 10: The frequency 156.850 MHz is additionally available to coast stations on the Great Lakes for transmission of scheduled Coded Marine Weather Forecasts (MAFOR), Great Lakes Weather Broadcast (LAWEB) and nscheduled Notices to Mariners or Bulletins. F3C and J3C emissions are permitted. Coast Stations on the Great Lakes must cease weather broadcasts which cause interference to stations operating on 156.800 MHz until the interference problem is resolved.
- 11: The frequency 157.100 MHz is authorized for search and rescue training exercises by state or local government in conjunction with U.S. Coast Guard stations. Prior U.S. Coast Guard approval is required. Use must cease immediately on U.S. Coast Guard request.
- 12: The duplex pair for channel 20 (157.000/161.600 MHz) may be used for ship to coast station communications.
- 13: Available for assignment to coast stations, the use of which is in accord with an agreed program, for the broadcast of information to ship stations concerning the environmental conditions in which vessels operate, i.e., weather; sea conditions; time signals; notices to mariners; and hazards to navigation.
- 14: Available only in the Puget Sound and the Strait of Juan de Fuca.
- 15: The frequency 156.525 MHz is to be used exclusively for distress, safety and calling using digital selective calling techniques. No other uses are permitted.
- 16: The frequency 156.450 MHz is available for intership, ship and coast general purpose calling by noncommercial vessels, such as recreational boats and private coast stations.
- 17: The frequency 156.425 MHz is assigned by rule to private coast stations in Alaska for facsimile transmissions as well as voice communications.

15 WARRANTY

Marine Products Limited Warranty

PLEASE NOTE

The following “Limited Warranty” is valid for products that have been purchased in the United States and Canada. For limited Warranty details outside the United States, contact the dealer in your country.

STANDARD HORIZON (a division of Vertex Standard) warrants, to the original purchaser only, each new Marine Communications Product (“Product”) manufactured and/or supplied by STANDARD HORIZON against defects in materials and workmanship under normal use and service for a period of time from the date of purchase as follows:

Fixed Mount and Portable Transceivers

1 year - if purchased before 01/01/91

3 years - if purchased between 01/01/91 and 01/01/94

3 years Waterproof - if purchased after 01/01/94

Loud hailers

1 year - if purchased before 01/01/91

3 years - if purchased after 01/01/91

Associated Chargers

1 year - if purchased before 01/01/91

3 years - if purchased after 01/01/91

Associated Batteries - 1 year. Note: Batteries will be deemed defective only if storage capacity drops below 80% of rated capacity or if leakage develops.

Associated Accessories - 1 year. Includes: Microphones/Handsets, External Speakers, Antennas, Carrying Accessories, Power Supplies, and Signaling Boards.

To receive warranty service, the purchaser must deliver the Product, transportation and insurance prepaid, to STANDARD HORIZON (a division of Vertex Standard), Attention Marine repairs 10900 Walker Street, Cypress, CA 90630. Include proof of purchase indicating model, serial number, and date of purchase. STANDARD HORIZON will return the Product to the purchaser freight prepaid. Products purchased prior to January 1, 1991 will bear the STANDARD HORIZON warranty terms in effect prior to that date.

In the event of a defect, malfunction or failure of the Product during the warranty period, STANDARD HORIZON's liability for any breach of contract or any breach of express or implied warranties in connection with the sale of Products shall be limited solely to repair or replacement, at its option, of the

Product or part(s) therein which, upon examination by STANDARD HORIZON, appear to be defective or not up to factory specifications. STANDARD HORIZON may, at its option, repair or replace parts or subassemblies with new or reconditioned parts and subassemblies. Parts thus repaired or replaced are warranted for the balance of the original applicable warranty.

STANDARD HORIZON will not warrant installation, maintenance or service of the Products. In all instances, STANDARD HORIZON's liability for damages shall not exceed the purchase price of the defective Product.

This warranty only extends to Products sold within the 50 States of the United States of America and the District of Columbia.

STANDARD HORIZON will pay all labor to repair the product and replacement parts charges incurred in providing the warranty service except where purchaser abuse or other qualifying exceptions exist. The purchaser must pay any transportation expenses incurred in returning the Product to STANDARD HORIZON for service.

This limited warranty does not extend to any Product which has been subjected to misuse, neglect, accident, incorrect wiring by anyone other than STANDARD HORIZON, improper installation, or subjected to use in violation of instructions furnished by STANDARD HORIZON, nor does this warranty extend to Products on which the serial number has been removed, defaced, or changed. STANDARD HORIZON cannot be responsible in any way for ancillary equipment not furnished by STANDARD HORIZON which is attached to or used in connection with STANDARD HORIZON's Products, or for the operation of the Product with any ancillary equipment, and all such equipment is expressly excluded from this warranty. STANDARD HORIZON disclaims liability for range, coverage, or operation of the Product and ancillary equipment as a whole under this warranty. STANDARD HORIZON reserves the right to make changes or improvements in Products, during subsequent production, without incurring the obligation to install such changes or improvements on previously manufactured Products.

The implied warranties which the law imposes on the sale of this Product are expressly LIMITED, in duration, to the time period specified above. STANDARD HORIZON shall not be liable under any circumstances for consequential damages resulting from the use and operation of this Product, or from the breach of this LIMITED WARRANTY, any implied warranties, or any contract with STANDARD HORIZON. IN CONNECTION WITH THE SALE OF ITS PRODUCTS, STANDARD HORIZON MAKES NO WARRANTIES, EXPRESS OR IMPLIED AS TO THE MERCHANTABILITY OR FITNESS FOR A PARTICULAR PURPOSE OR OTHERWISE, EXCEPT AS EXPRESSLY SET FORTH HEREIN.

Some states do not allow the exclusion or limitation of incidental or consequential damages, or limitation on how long an implied warranty lasts, so the above limitations or exclusions may not apply. This warranty gives specific legal rights, and there may be other rights which may vary from state to state.

ONLY PRODUCTS SOLD ON OR AFTER JANUARY 1, 1991 ARE COVERED UNDER THE TERMS OF THIS LIMITED WARRANTY.

ON-LINE WARRANTY REGISTRATION

THANK YOU for purchasing a Standard Horizon products! We are confident your new radio will serve your needs for many years!

Please visit **www.standardhorizon.com** to register the **HX851** Marine VHF. It should be noted that visiting the Web site from time to time may be beneficial to you, as new products are released they will appear on the STANDARD HORIZON Web site. Also a statement regarding product support should be added to the manual.

Product Support Inquiries

If you have any questions or comments regarding the use of the **HX851**, you can visit the STANDARD HORIZON Web site to send an E-Mail or contact the Product Support team at (800) 767-2450 ext 6300 M-F 7:00-5:00PST.

In addition to the warranty, STANDARD HORIZON includes a lifetime "flat rate" and "customer loyalty" programs to provide service after the warranty period has expired. If you wish to obtain the flat rate price for out-of-warranty repair, you must include the information on the Owner's Record with the unit when you return it to your Dealer or to STANDARD HORIZON.

Lifetime Flat Rate Service Program: For the original Owner only, for the lifetime of the unit, STANDARD HORIZON will repair the unit to original specifications.

Note: The flat rate amount is payable by the Owner only if STANDARD HORIZON or the STANDARD HORIZON Dealer determines that a repair is needed. After the repair, a 90-day warranty will be in effect from the date of return of the unit to the Owner.

This service program is not available for equipment which has failed as a result of neglect, accident, breakage, misuse, improper installation or modification, or water damage (depending on the product).

16 INSTALLATION OF OPTIONS

16.1 FBA-38 ALKALINE BATTERY CASE

The optional **FBA-38** is a battery case that holds five “AAA” size Alkaline batteries and is used with the **HX851** transceiver. The Alkaline batteries can be used for receiving and transmission in an emergency, and battery life will be shortened dramatically. When the Alkaline batteries are used, we recommend to reduce the Transmit Output Power to “**LOW**” to conserve battery life.

1. Slide the five “AAA” size Alkaline batteries into the **FBA-38** with the Negative (-) side of the batteries touching the spring connections inside the **FBA-38**.
2. Insert the **FBA-38** into the battery rest on the bottom of the transceiver, and then turn the Battery Pack Lock to the “**LOCK**” position with a coin.

NOTE

When the **FBA-38** Alkaline Battery Case is used, the **HX851** is not able to transmit using 6 W power output.

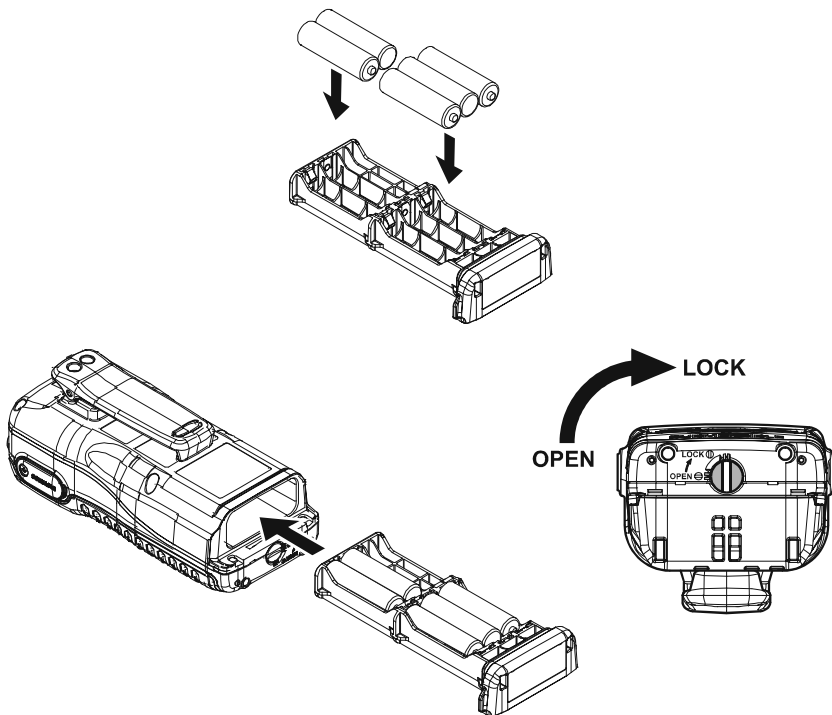

17 SPECIFICATIONS

Performance specifications are nominal, unless otherwise indicated, and are subject to change without notice. Measured in accordance with TIA/EIA-603.

17.1 GENERAL

Frequency Range:	TX: 156.025 MHz - 157.425 MHz RX: 156.050 MHz - 163.275MHz
Channel Spacing:	25 kHz
Frequency Stability:	±10 ppm (-4 °F to +140 °F [-20 °C to +60 °C])
Emission Type:	16K0G3E for Voice, 16K0G2B for DSC
Antenna Impedance:	50 Ω
Supply Voltage:	7.4V DC, Negative Ground (Battery Terminal)
Current Consumption:	330 mA (Receive) 100 mA (Standby, GPS On) 60 mA (Standby, GPS Off) 1.6 A / 1.6 A / 1.0 A / 0.7 A (TX: 6W / 5 W / 2.5W / 1W)
Operating Temperature:	-4 °F to +140 °F (-20 °C to +60 °C)
DSC Individual Directory:	24 Memories
DSC Group Directory:	8 Memories
NMEA Input:	GLL, GGA, and RMC
NMEA Output:	DSC, DSE, GLL, GGA, GSA, GSV, and RMC
Case Size (W x H x D):	2.46" x 5.57" x 1.77" (62.5 x 141.5 x 45 mm) (w/o knob & antenna)
Weight:	11.8 oz (335 g) w/ FNB-V99LI, belt clip & antenna

17.2 TRANSMITTER

RF Power Output:	6 W / 5 W / 2.5 W / 1 W (@7.4 V)
Modulation Type:	Variable Reactance
Maximum Deviation:	±5 kHz
Spurious Emission:	-75 dBc typical
Microphone Impedance:	2 kΩ

17.3 RECEIVER

Circuit Type:	Double-Conversion Superheterodyne
Intermediate Frequencies:	1st: 47.25 MHz 2nd: 450 kHz
Sensitivity:	0.25 μ V for 12 dB SINAD
Adjacent Channel Selectivity:	70 dB typical
Intermodulation:	70 dB typical
Hum & Noise Ratio:	40 dB
Selectivity:	12 kHz / 25 kHz (-6 dB / -60 dB)
AF Output (Internal SP):	700 mW @16 Ω for 10 % THD (@7.4 V)

17.4 GPS

Receiver Channels:	12 channels
Sensitivity:	Less than -130 dBm
Time to First Fix:	1 min typical (@Cold Start) 40 sec typical (@Warm Start)
Geodetic Datum:	WGS84

This device complies with part 15 of the FCC rules. Operation is subject to the condition that this device does not cause harmful interference.

Part 15.21: Changes or modifications to this device not expressly approved by Vertex Standard could void the User's authorization to operate this device.



Marine Division of VERTEX STANDARD

US Headquarters

10900 Walker Street, Cypress, CA 90630, U.S.A.

Copyright 2010
VERTEX STANDARD CO., LTD.
All rights reserved.

No portion of this manual
may be reproduced
without the permission of
VERTEX STANDARD CO., LTD.



E M 0 3 1 N 1 7 1