



LUXFER'S SCUBA CYLINDER VISUAL INSPECTION GUIDE

A Guide to the Visual Inspection of Luxfer Scuba Cylinders

Copyright © 1998 by Luxfer Inc. All rights reserved.

Except as permitted under the U.S. Copyright Act of 1976,
no part of this book may be reproduced in any form without
the express written consent of Luxfer Inc.

Published in the USA by Luxfer Inc.

3016 Kansas Avenue
Riverside, CA 92507
USA
Telephone: 1-909-684-5110
FAX: 1-909-781-6598

Second Edition
Sept. 1998

LScuG2.1998

Table of Contents

Introduction	1
Visual Inspection Procedures	5
1. Frequency of Inspection	5
2. Before Inspection Begins	6
3. Preparing The Cylinder For Inspection.....	9
4. Exterior	12
5. Threads.....	14
6. Interior	16
7. Miscellaneous	18
8. Cylinder Condition - The Decision.....	19
9. Re-Installing Valves	21
10. Filling the Scuba Cylinder	22
Notes	23
Appendices	37
Appendix A.....	37
Appendix B	38
Appendix C	41
Appendix D.....	42
Appendix E.....	44
Appendix F.....	46
Glossary/Appendix G.....	47
Figures/Photos	55



INTRODUCTION

Scuba cylinders are extremely tough and designed for the hard service they receive. To provide many years of safe and trouble-free diving, a scuba cylinder must be well cared for and properly maintained. Crucial to that care and maintenance is the complete visual inspection every scuba cylinder must undergo at least once a year during service.

Anyone carrying out a visual inspection assumes considerable responsibility. The consequences of an incomplete or superficial inspection can be severe for you, your co-workers and your customers.

Many of you in the dive industry recognize the extent of this responsibility and the need to be professionally trained and equipped to carry out visual inspections. This is evidenced by the success of *Luxfer's Guide to Scuba Cylinder Visual Inspection*. Published in 1994, the first edition of 2,500 copies has been distributed around the world.

In response to the continuing demand for the *Guide*, Luxfer decided not to simply to reprint the first edition but to take the opportunity to update its contents, particularly to include suggestions made by users of the *Guide*. This Second Edition is now an even better source of everything you need to know about the visual inspection of Luxfer's scuba cylinders.

A word of caution, however. This *Guide* is **not** intended to replace the need for professional training in how to carry out a professional visual inspection. In fact, Luxfer strongly recommends such training and this *Guide* includes a resource list of known training agencies. This *Guide* will, however, provide the trained inspector with all the procedures and standards for visual inspections and additional resources a technician will need to carry out a thorough, professional visual inspection of a Luxfer scuba cylinder.

It is important to remember that this *Guide* was written for the inspection of Luxfer high-pressure aluminum cylinders **only**. If you carry out visual inspections of other aluminum or steel cylinders, we recommend you secure proper training and read *Inspecting Cylinders* by William L. (Bill) High of Professional Scuba Inspectors, Inc. (PSI).

The professional staff at Luxfer who worked on producing the Second Edition of this *Guide* want to acknowledge the considerable assistance and support received from many members of the dive community in making this *Guide* possible.

NOTES:

- In developing these procedures and standards, Luxfer has complied with all known US DOT and other applicable governmental regulations and CGA standards applicable to all-metal cylinders in the USA.
- In jurisdictions outside the USA, refer to your local regulations which may override any recommendations made in this Guide.
- **Remember, this Guide applies to the visual inspection of Luxfer-manufactured cylinders only.**

HOW TO USE THIS GUIDE

This Guide provides you, the technician, with step-by-step instructions on how to carry out a visual inspection of all types of Luxfer scuba cylinders manufactured in the USA.

Before you begin any inspection, you should make yourself familiar with the contents of this Guide.

Included in the Guide are the following sections:

- 1. Categorizing Your Cylinder: Before you begin your inspection, you must determine what kind of cylinder you are about to inspect.
- 2. Frequency of Inspection: You must also decide how frequently you are going to inspect your scuba cylinders. This will depend partly upon the condition of the cylinder and how often it is used.
- 3. Before Inspection Begins: Everything you need to know to get ready for an inspection.
- 4-10. The Inspection Process: In seven sections, everything you need to know to take you through the inspection process.
- The NOTES: There is much information about the inspection procedures which, if included in the Inspection Process, would make it unwieldy and difficult to read. These NOTES are an important part of the Inspection Process and will help you understand some of the reasons **why** a particular instruction was given, or may elaborate on a particular point, or may explain how to do something. You **must** read and understand the NOTES before you conduct visual inspections on an scuba cylinder. We recommend that you review the NOTES frequently.
- The APPENDICES: Useful lists and forms as well as sources for equipment, accessories and further technical references. Each APPENDIX should be reviewed as needed after its first reading. The Glossary of Terms is one of the Appendices.
- FIGURES and PHOTOS: To help you recognize things to look for during an inspection. Review them all before and while you are reading the Inspection Process sections.

WARNINGS:

- **Before using this Guide for the first time, read through and become familiar with all the sections, including the NOTES, APPENDICES, FIGURES and PHOTOS. If any part is unclear, contact Luxfer before inspecting the first cylinder. Remember, Luxfer recommends professional training for anyone visually inspecting cylinders.**
- **This Guide applies to visual inspections of Luxfer scuba cylinders only. This Guide is not intended for the inspection of any other Luxfer cylinder; nor for inspecting scuba cylinders, valves or other scuba components produced by another manufacturer. Contact the relevant manufacturer for their inspection materials.**
- **To eliminate the risk of fire and serious injury, never fill a Luxfer scuba cylinder with pure oxygen or oxygen-enriched air mixture or any other special gas. See NOTE 2 for additional information.**

IMPORTANT

References to the NOTES, APPENDICES, FIGURES and PHOTOS in the following text are shown by the use of superscript numbers or letters and numbers, as follows:

NOTES: Superscript number alone, such as Luxfer Gas Cylinders⁷ (i.e. NOTE 7)

APPENDICES: Superscript letter alone, such as The FORM^G (i.e. APPENDIX G)

FIGURES: Superscript F with number, such as ^{F4} (i.e. FIGURE 4)

PHOTOS: Superscript P with number, such as ^{P14} (i.e. PHOTO 14)

To contact Luxfer Gas Cylinders, see NOTE 7 for information.

This page is intentionally left blank.



VISUAL INSPECTION

1 FREQUENCY OF INSPECTION

A. **NORMAL SERVICE.** The visual inspection of every Luxfer scuba cylinder should take place at least once every twelve months, or at any opportune time under twelve months¹⁵. Some scuba cylinders need more frequent visual inspection, as indicated below.

B. **HEAVY SERVICE.** If the cylinder is used in heavy service then it should be inspected *every four months*.

“Heavy service” means any one or more of the following:

1. Cylinders being filled or “topped off” five or more times per week;
2. Rental cylinders in use during the ‘season’ and ‘off-season’ times;
3. Cylinders used wherever damage is more likely than in normal use or where the care and/or maintenance is slightly below recommended care.⁴

C. **KNOWN CONDITION.** If the cylinder is known to have had any unusual treatment or condition, it should be *immediately* visually inspected, prior to its next use.

“Unusual treatment or condition” means if the cylinder:

1. Dropped, fell, was struck, was in an accident, or when the care and maintenance of the cylinder is obviously poor;
2. Was stored improperly⁴ and shows signs of damage;
3. Has obvious corrosion since the last visual inspection;
4. Has a gouge, dent, scrape, cut, dig or, in any way, has been damaged since the last visual inspection;
5. Was stored with water, material or matter inside the cylinder;
6. Shows signs of exposure to fire or high heat, including any one or more of the following:
 - a. Charring or blistering of the paint or other protective coating;
 - b. Melting or charring of the metal;
 - c. Distortion of the cylinder and/or any cylinder accessory;
 - d. Melting of fuse plugs, valve handwheel, valve protector, and/or any other valve component or cylinder accessory;
7. Has been partially or fully repainted or treated to hide damage and/or fire damage;
8. Is known or suspected to be leaking; or,
9. Is known or suspected of having a crack.

Inspectors should be familiar with all conditions that could CONDEMN a Luxfer Gas Cylinders scuba cylinder from further use.

WARNING: Should an incident occur that could damage a cylinder, the cylinder should be immediately taken out of service, inspected and if needed, condemned.

2 BEFORE INSPECTION BEGINS

If there is any part of the following procedure that is unclear, please contact Luxfer Gas Cylinders⁷ for assistance.

A work station should be made ready to do visual inspections. Select an area and table which will not cause damage to the cylinder or valve. The table should be flat, level, and padded (e.g., old carpet, carpet remnants, rugs, etc.). Lighting in the area should be bright. The table should be equipped with a holder or blocks to keep a cylinder on its side from rolling, without damaging the cylinder.

The inspector should be alert, clear-headed, and observant. The visual inspection depends upon the knowledge, experience and senses of the inspector.

We recommend that all inspectors responsible for visual inspections be trained and accredited as visual cylinder inspectors. For a listing of inspection training agencies, see APPENDIX A.

The inspection equipment and accessories should be gathered together. A list of accessories can be found in APPENDIX B and of accessory sources in APPENDIX C. All equipment and accessory items should be inspected before use for defects, damage, and all should be made fully operational.

Have a completed and properly signed CUSTOMER RELEASE FOR CYLINDER INSPECTION FORM (see APPENDIX E) from the customer.

Have a clean, blank SCUBA CYLINDER VISUAL INSPECTION FORM (hereafter referred to as THE FORM) ready for each cylinder to be inspected (for sample, see APPENDIX D). Complete the customer information on THE FORM, from the customer at time of acceptance. Verify it matches the information in the CUSTOMER RELEASE FOR CYLINDER INSPECTION FORM.

A log may be used and kept by an inspector instead of THE FORM, when the cylinders are all owned by the inspecting group (e.g., the inspectors doing the inspecting are employees of a cylinder rental company which owns and maintains the rental cylinders. If this rental company offered inspection services to other cylinder owners, we recommend that they use THE FORM.)

Before accepting the cylinder, ask the customer to keep/remove all external accessories from the cylinder (i.e., backpack, cover, boot, bands, straps, etc.). If the removal of any such accessory may result in cylinder damage, or make the cylinder unusable, then the owner should definitely remove the accessory, him/herself. Only the cylinder itself is needed for this inspection. If the cylinder is valved when received, the inspector should remove it prior to inspection, as suggested below.

The cylinder must be empty of air for inspection. Slowly discharge all air from the valved cylinder according to recommendations by the valve manufacturer. Record if any leak was detected (see section 5A. below). We recommend that the slow discharge take longer than ten minutes.

When the cylinder is empty, remove the valve. The valve should be removed according to valve manufacturer recommendations, so that the valve and cylinder are not damaged.

WARNING: If the valve is damaged or not functioning properly, the inspector/operator may think that the cylinder is empty after opening the valve and not hearing any gas released. All valved cylinders thought to be empty should still be handled as if they are under pressure, and the valve removed carefully, according to the valve manufacturer's guidelines.

If for any reason the valve is hard to remove, stop.

Check to see that the valve is functioning properly by adding a small amount of air to the cylinder to prove that air goes in and out of the valve. Proceed to remove the hard-to-remove valve, only after this valve check shows that the valve is working right. Contact the valve manufacturer if the valve isn't working right.

We recommend the inspection of the valve at this time, if it came with the cylinder for visual inspection. Contact the valve manufacturer for the proper inspection procedure of the valve.

Remove any loose paint or anything obstructing the reading of the stamped cylinder information located on the crown of the scuba cylinder (see FIGURES 1 - 4 and NOTE 16). If any such removal may result in damaging the cylinder, contact the owner to resolve how the inspection should proceed.

WARNING: If a condemning feature is found during the visual inspection of a scuba cylinder, the inspection stops there.

Complete the end of THE FORM and follow the procedure outlined below in section VIII C below when a condemning feature is discovered.

The cylinder is ACCEPTABLE unless a condemning condition is found.

RECORD every observation on THE FORM. If a condemning feature or condition is found, go to the end of THE FORM and complete the last section.

Leave no place blank on THE FORM and be descriptive in your fill-ins. A completed copy of THE FORM is to be kept by the inspector and a copy is to be given the owner.

Indicate at the bottom of THE FORM that the cylinder is ACCEPTABLE, or CONDEMN based upon your recorded observations and determinations.

At no time may a visual inspector put any markings on a cylinder to be returned to service.

3 PREPARING THE CYLINDER FOR INSPECTION

The visual inspection begins by:

- recording cylinder markings,
- making general observations,
- removing any inside water, materials, debris or contents, and finally
- preparing the cylinder interior for the inspection procedure.

3A CYLINDER MARKINGS

RECORD all relevant cylinder information from the cylinder on the SCUBA CYLINDER VISUAL INSPECTION FORM (See APPENDIX D- Referred to as “THE FORM” below).

Include marking information you see including: Government specification, service pressure, serial number, original and latest hydro date. See FIGURES 1 - 4 for examples.

The four FIGURES depict one example of each cylinder marking style, used through the years. “Marking examples” under each diagram show markings you might find. In other words, look at each FIGURE as an example of one marking design. Then read the list of Markings below the diagram to learn what different markings could be in that design.

RECORD if the cylinder was received under pressure or empty.

WARNING: Luxfer Gas Cylinders scuba cylinder marking does not include the plus sign (+). If a plus sign is found on the cylinder, contact Luxfer Gas Cylinders.⁷

RECORD if you are aware that the cylinder had been previously inspected and found to be marginally acceptable.

CONDEMN all cylinders with altered, or unreadable serial numbers; first hydrostatic test date; current hydrostatic test date; and/or working pressure. (See FIGURES 1 - 4.)

DO NOT RETURN TO SERVICE any cylinder that has not been hydrostatically tested within the last five years. (See Note 1.)

3B EXTERNAL CONDITIONS

RECORD what you know or can see about the cylinder-cylinder condition (signs of wear), maintenance, exposure to unusual treatment or conditions, evidence of exposure to heavy service or extreme/hazardous service, (see section I above and Glossary in APPENDIX G for definitions of the types of service) or knowledge about exposure to heat and/or fire.

RECORD fresh paint if found. If fresh paint is found, get information from the owner about how *and* why it was painted and how the paint was cured and dried.

RECORD this information on THE FORM, too.

CONDEMN all cylinders exposed to heat over 350°F or that have been exposed to fire, or that the inspector has reason to believe may have been exposed to a heat over 350°F.

WARNING: If you suspect a cylinder has been heated to temperatures BETWEEN 265°F (130°C) a retested prior to use. Cylinders exposed or with evidence of exposure to heat in excess of 350°F from service.

CONDEMN all cylinders which exhibit any arc or torch burns, or fire damage. (See PHOTO 13.)

CONDEMN all cylinders that were repainted and heated over 350°F to dry or cure the paint.

HOLD all cylinders with fresh paint for a hydrostatic retest, unless the inspector is sure the fresh paint doesn't hide an imperfection (see 'imperfection' in Glossary.⁶ Fresh paint may also hide heat damage.

WARNING: Do not return to service any cylinder with hidden heat or physical damage that can't be visually inspected. Contact owner.

3C INTERNAL CONTAMINATION

Pour out any contaminating material from the interior into a sufficiently strong and large bowl or container.

RECORD on THE FORM any unusual odors.

Inspect any and all material or matter that was poured from the cylinder. Identify and/or describe this material on THE FORM.¹¹ If at this time the cylinder has 'stuck' material in it, invert the cylinder over a white piece of paper, holding it about one half inch (1/2 inch) above the paper. Then allow the cylinder to drop onto the paper, releasing any of the remaining contents of the cylinder onto the paper.

Bag all these materials in a plastic bag or seal in a jar, to show the owner. Determine the source of any contents. RECORD observations¹¹ on THE FORM. RECORD the kind and source of contents.

HOLD all cylinders with gummy internal substances, oil and/or debris, or which have an offensive odor, for internal cleaning.¹⁷ Contact owner for permission to clean the cylinder.

DO NOT RETURN TO SERVICE any cylinder with an internal contaminate. After cleaning,¹⁷ the cylinder may then be reinspected (starting at the beginning of this procedure).

If water, debris, lubricants, oils, etc. are found inside the scuba cylinder, then train and educate the owner on the proper care and maintenance of cylinders.⁴ Ask them to follow the recommendations.

4 EXTERIOR

- The entire exterior of the cylinder must be exposed to the inspector and not concealed.
- There should be no cylinder equipment attached during the inspection process.
- There should be no external material or condition which prevents a visual inspection of the surface.
- If there are external contaminants, refer to NOTE 16 for proper cleaning of the exterior.
- If labeling may hide or is suspected to hide a cylinder imperfection (see ‘**imperfection**’ in the Glossary⁶), remove label¹⁸.

4A BULGES, BOW AND DENTS

Check for bulges, bow (“banana”) and dents. Roll cylinder on padded table to find bulges and bow; hold a straight edge against its sidewall in several places and the base, to find dents and more bulges or bow. Check crown for dents. (See PHOTOS 1 and 18, and FIGURES 10 and 11.)

Determine the dent depth and diameter using a straight edge and ruler. RECORD this information and the location of the dent on THE FORM.⁶ Read NOTE 6.

Look for a bow and bulges: If a straight edge rises from the cylinder sidewall and light is clearly visible between the edge and cylinder surface, then a bulge or bow is indicated. Further determine if the condition is a bow or bulge.

If the shape of the cylinder is a curve¹⁸ then RECORD on THE FORM that the cylinder is bowed.

If the rise is in a distinct area and is definitely visible (light is clearly seen between the straight edge and the cylinder and the straight edge wobbles on bulge,^{F10} then record on THE FORM as a bulge. RECORD the bulge’s location on THE FORM.⁶

CONDEMN all cylinders with dents 0.060 inch (1.53 mm) or greater in depth.

CONDEMN all cylinders with dents measuring less than two inches (50mm) in diameter.

CONDEMN all cylinders with definite visible bulges.

RETURN TO SERVICE all bowed cylinders. If unsure whether it is a bow or bulge, refer to FIGURES 10 and 11, and PHOTO 18. Contact Luxfer Gas Cylinders⁷ if you are still unsure.

4B CUTS, GOUGES, SCRATCHES

Check for cuts, digs, gouges and scratches. (See APPENDIX G for definitions. See PHOTOS 2 and 3.) Gently and carefully, with a file, smooth any upset metal (metal raised up from the cylinder surface from the cut, dig, gouge, or scratch) without causing damage to the cylinder. This is in order to get a true depth measurement of the cut, dig, gouge or scratch.

Measure the length, depth and location of all cylinder surface cuts, digs, gouges or scratches.⁶ RECORD information and location(s) on THE FORM.

CONDEMN all cylinders with surface cuts, digs or gouges in the metal that are either longer than six inches (152mm), or deeper than 0.030 inch (0.76 mm).

4C EXTERNAL SURFACE CORROSION

Check external surface for corrosion. Determine type of corrosion and the depth of what seems to be the deepest pit, or deepest part of the broadspread corrosion (see NOTES 5 and 6).

Record the location and whether the corrosion is isolated pit corrosion, line, or broadspread corrosion on THE FORM. (For visual examples, see FIGURE 9 and PHOTOS 11 and 12.)

CONDEMN all cylinders with one or more external corrosion pits over 0.060 inch (1.53 mm) deep in the sidewall, crown, and/or base.

CONDEMN all cylinders with external line or broadspread corrosion when one or more pit, or the broadspread corrosion, is over 0.030 inch (0.76 mm) deep in the sidewall or crown.

CONDEMN all cylinders with external line corrosion over 6 inches (152 mm) long.

CONDEMN all cylinders with external broadspread corrosion covering more than 25% (one fourth) of the cylinder.

If other pits are present, check a few more to be sure the cylinder is fit to return to service.

5 THREADS

- Thread imperfections include metal loss, galling, corrosion, cracking and abuse.
- Abuse can appear as deep nicks, broken threads, cross threads, stripped threads, and threads without well defined and sharp peaks.
- Careful inspection of threads is critical to the proper operation and safety of the Luxfer scuba cylinder.
- Be familiar with what is known as a tool stop mark (see NOTE 14, PHOTO 10, and see the Glossary, APPENDIX G for definitions of the various kinds of thread imperfections.)
- Clean threads of debris and lubricant⁹ before proceeding.

5A LEAKING VALVE CONNECTION

From information gathered while releasing any pressurized air, or from prior knowledge, RECORD if you are aware that the cylinder has been leaking at the valve connection.

Determine the cause of the leak^{f6} (e.g., valve, O-ring, cylinder threads, cylinder, etc.).

CONDEMN all cylinders where the leak at the valve connection is caused by a damaged cylinder, defective threads, or imperfections in the neck area.

5B THREAD IMPERFECTIONS

Inspect clean cylinder threads with and without a dental mirror and light. (See NOTE 8, and PHOTOS 4 - 9).

RECORD the location of all thread imperfections (damaged, missing, and cross threads).

Count the number of continuous full threads starting at the top, that do not have any imperfection. RECORD this number of good threads on THE FORM.

Review the cylinder's recorded service pressure and then:

CONDEMN all 2015 to 3000 psig cylinders that have less than **SIX** continuous full threads without imperfection, counting from the top.

CONDEMN all 3100 to 3300 psig cylinders that have less than **NINE** continuous full threads without imperfection, counting from the top.

CONDEMN all 3400 to 3500 psig cylinders that have less than **TEN** continuous full threads without imperfection, counting from the top.

5C CRACKED CYLINDER THREADS

Inspect all cylinder threads for cracking with and without a dental mirror and light. See PHOTOS 6 - 9. In addition to a visual inspection using the naked eye, the use of a Non-destructive Testing (NDT)⁶ device, such as Visual Plus^{B&C} is also recommended to detect thread cracks.

Remove the O-ring. Inspect the O-ring gland and cylinder face^{F5/6} for cracking.

CONDEMN all cylinders that show evidence of cracking in more than one continuous full thread. Contact Luxfer⁷ with this information and findings.

CONDEMN all cylinders with O-ring gland or face cracks. Contact Luxfer⁷ with this information and findings.

CONDEMN all cylinders with O-ring gland or face damage.

RETURN TO SERVICE all cylinders with tool stop marks^{P10} on otherwise acceptable threads, with acceptable glands and faces.

5D FOLDS AND VALLEYS IN THREADS

Inspect cylinder threads near the bottom of the threads, with a dental mirror and light⁸ for folds and valleys (for visual illustrations, see FIGURES 6 - 8 and PHOTOS 14 - 17) that enter into the thread area.

RECORD the findings on THE FORM.

CONDEMN all cylinders with valleys that reduce the number of defect-free, continuous full threads below the minimum (according to the limits defined in section 5B.), counting from the top. Contact Luxfer Gas Cylinders⁷ with this information and findings.

CONDEMN all cylinders with a fold which enters into more than one thread. Contact Luxfer Gas Cylinders⁷ with this information and findings.

5E THREAD IMPERFECTIONS

Inspect cylinder threads for any other imperfections (see 'imperfection'⁶). Check for corrosion (on cylinder thread as well as valve thread, if valve is available).

RECORD on THE FORM any observation of thread imperfections.

CONDEMN all cylinders with thread imperfections which reduce the number of continuous full threads below the limits defined in section 5B above.

CONDEMN all cylinders with corrosion in any thread that is a required continuous full thread identified in section 5B above.

6 INTERIOR

- Nothing must obscure the interior surface of the cylinder from this visual inspection.
- If the interior surface cannot be seen after removing loose contents and water (because of such things as stains, deposits, heavy corrosion, material still clinging to the inside, etc.), arrange to have the cylinder tumbled.
- You will need to get the owner's permission to tumble the cylinder.¹³
- Proceed only if the interior surface is readily visible.
- See NOTE 12 for further information on standard interior surface appearances in Luxfer scuba cylinders.

6A INTERIOR THREAD AREA

Inspect all cylinders with a dental mirror and light, just below the threads and inside the cylinder crown area, for any sign of cracks, folds and valleys.¹⁰ (See PHOTOS 14 - 17 and 20, and FIGURES 6 - 8.)

Determine the location of any crack, fold, and valley. Measure the depth of any and all folds.

RECORD all information on THE FORM.

CONDEMN all cylinders that show evidence of cracking.^{p20} Contact Luxfer⁷ with this information and findings.

CONDEMN all cylinders with one or more folds in the interior crown area deeper than 0.060 inches (1.53 mm). Contact Luxfer⁷ with this information and findings.

ACCEPT all cylinders with interior valleys¹⁰ in the crown area.

6B METAL IRREGULARITIES

Inspect cylinder interior with a light for any metal irregularities. Cylinders may show interior irregularities that may have been caused by exterior impacts.

RECORD the location and observations of all such irregularities on THE FORM.

Contact Luxfer Gas Cylinders⁷ with any observations you question.

CONDEMN all cylinders that show any cracks or metal distortions in the interior sidewall and base. Contact Luxfer Gas Cylinders⁷ with this information and findings.

CONDEMN all cylinders with metal distortions in the crown other than allowable valley and fold imperfections (see Section 5D.) Contact Luxfer Gas Cylinders⁷ with this information and findings.

6C INTERIOR CORROSION AND PITTING

Inspect interior sidewall, crown and base, with a light for any corrosion or pitting. Determine the type, depth, location and length (for line corrosion) of the corrosion.^{5/6} For visual illustrations, see PHOTOS 11 and 12. RECORD location, type and depth of corrosion on THE FORM.

CONDEMN all cylinders with any interior sidewall, crown, or base isolated pit estimated to be over 0.060 inch (1.53 mm) deep.

CONDEMN all cylinders with interior sidewall line or broadspread corrosion when one or more interior pit in the line corrosion is deeper than 0.030 inch (0.76 mm), and/or if the interior broadspread corrosion is deeper than 0.030 inch (0.76 mm).

CONDEMN all cylinders with interior sidewall line corrosion that is over 6 inches (152 mm) long.

HOLD cylinder for internal cleaning¹³ if corrosion obstructs a clear view of the interior's surface. Contact the owner for cleaning approval.

CONDEMN all cylinders with internal broadspread corrosion covering more than 25% (one fourth) of the cylinder.

If other pits and/or corrosion are found, check them to determine if the cylinder is fit to return to service.

Train and educate the owner on the proper care and maintenance⁴ of the cylinder if any corrosion is found. Ask that they follow the recommendations.

7 MISCELLANEOUS

This procedure does not cover valve inspection, or the inspection of any cylinder accessories. Check with the manufacturer of these items for their handling and inspection.

Especially check with the manufacturer on the inspection of any valve component (rupture discs, dip tube, valve threads, O-rings, etc.) and the condition which requires their replacement.

If the valve or valve component didn't pass inspection, or, if the valve was not inspected at all, do not attach the valve to the cylinder. Instead, return each separately to the owner, explaining the concern, problem or that the valve was not inspected.

The end of THE FORM is set aside to describe these and other concerns or problems with accessories, or the cylinder, that were not covered above.

RECORD specific and clear comments.

8 CYLINDER CONDITION – THE DECISION

A. If there were no recorded conditions that would condemn the cylinder, then RECORD on THE FORM the cylinder status as ACCEPTABLE. Proceed to section 8E.

B. If the cylinder has a feature or condition which would condemn it, then the inspection stops, and the condemning feature is recorded on THE FORM. Proceed to section 8C.

WARNING: Before a cylinder is condemned, we recommend:

1. that a signed CUSTOMER RELEASE FOR CYLINDER INSPECTION^E is on file (and see section I, BEFORE INSPECTION BEGINS, above); and,
2. that a second or third inspector, familiar with this Luxfer Visual Inspection Procedure be consulted and asked to confirm the condition(s), which would condemn the cylinder.

C. Procedures for handling a condemned cylinder:

1. **In the U.S.A.** Thoroughly review NOTE 7. After following recommendations in the Warning above, we recommend that condemned cylinders in the U.S.A. are rendered unusable in one of two ways (unless local or state regulations require another procedure):
 - a. If the cylinder is condemned during this inspection and is to be returned to Luxfer,⁷ we recommend, in the U.S.A., to strike out the stamped markings on the cylinder crown, leaving the serial number and hydrostatic test dates visible. **Do not destroy the threads.**

Tell the owner to contact Luxfer⁷ to make arrangements for returning the cylinder to Luxfer.⁷
 - b. If the cylinder is condemned during this inspection and is not to be returned to Luxfer,⁷ we recommend, in the U.S.A., that the cylinder is made unusable by destroying the threads.
2. **Outside the U.S.A.** Cylinders used outside the U.S.A. should be condemned according to the specifications set by that country. If possible and in accordance with the foreign specifications, do not damage threads on, nor drill holes in, those cylinders to be returned to Luxfer.⁷
3. If condemned, the inspection stops. After rendering the cylinder unusable, return a copy of THE FORM to the customer along with the condemned cylinder, any accessories, valve, etc. Do not attach any components to the condemned cylinder.

Proceed to section 8E.

- D. Cylinders to be returned to service should have a legible Luxfer Caution label attached to the exterior and we recommend that all ACCEPTABLE cylinders be returned to service with an inspection sticker applied to the cylinder, indicating it has passed the inspection and is a safe and useable cylinder.
- E. Date and sign THE FORM. Return cylinder and any accessories received with cylinder, and give the customer a copy of THE FORM and a copy of the Luxfer scuba cylinder care and maintenance instructions.⁴

NOTE: If the cylinder is ACCEPTABLE and is to be re-valved, then continue on to Section 9 prior to returning the cylinder and a copy of THE FORM to the customer.

9 RE-INSTALLING VALVES

If the valve and valve components have passed inspection (from information obtained from the valve manufacturer), and if the cylinder has passed inspection, then the valve may be reinstalled as suggested below.

The application of a small quantity of lubricant to the valve threads is essential for the proper care of the valve and cylinder. We recommend that only Dow Corning Compound 111 be used on valve threads.

Only a very small amount of the lube is needed, and only applied at the bottom of the valve threads. The lubricant will ride up the threads as it is installed. We only recommend this lubricant since it has proven compatible with cylinders and valves, doesn't add any grease or oil to the cylinder, is safe to use, and helps prevent galvanic corrosion.

WARNING: Never use any kind of tape wrap, oils, vaseline or petroleum products on valves installed into high-pressure Luxfer Gas Cylinders scuba cylinders.

We recommend that all straight thread valves be installed in Luxfer high-pressure aluminum scuba cylinders with a torque recommended by the valve manufacturer for aluminum cylinders.

Without a recommended torque from the valve manufacturer, we would recommend a torque of 50 lbf-ft, plus or minus 10 lbf-ft. All torquing should be done such that valve, valve components and cylinder are not damaged.

RECORD valve and reinstallation information on THE FORM. If both cylinder and valve pass inspection, return valved cylinder and a copy of THE FORM to the customer.

Return all accessories received with cylinder.

10 FILLING THE SCUBA CYLINDER

The Luxfer scuba cylinder can be filled and re-used for many years. If the scuba cylinder is properly cared for and maintained and the recommendations in this Guide are followed carefully, the Luxfer cylinder will provide long, safe and reliable service.

As part of a safe and proper fill procedure, be aware of and familiar with any and all filling guidelines, regulations requirements and laws of the applicable local, county, state/provincial and federal agencies. Many agencies, authorities and organizations have made rules and/or standards on how to fill and use scuba cylinders.

In the USA, some of these agencies include, but are not limited to: NIOSH, OSHA and DOT. Your state/province may have made rules for you to follow for the safe filling of scuba cylinders with air. One such state is New Jersey and its agency, PEOSH. Some agencies (like PEOSH) regulate publicly owned/operated emergency response personnel safety. Such agencies may have rules that cover not only how to fill, but also requirements for personnel qualifications, equipment, inspections and safeguards, as well as the quality of the air to be used.

Similarly, know and be aware of any applicable industry or professional guidelines. Many organizations have issued guidance documents and standards covering the use and filling of scuba cylinders.

WARNING: Do not fast fill^c (1,000 psig or higher) scuba cylinders. A fill rate of between 300 - 600 psig/minute is recommended.



NOTES

1. Hydrostatic retesting and re-certification of scuba cylinders is required in the U.S.A. every five years or less of service life of the cylinder in interstate service. In addition, the retest has become an industry standard no matter where the scuba cylinder is used. The U.S.A. Department of Transportation (DOT), through the Research and Special Programs Administration (RSPA) agency, issues inspection station numbers to retest stations who may legally perform hydrostatic retesting. Only the DOT has the authority to issue such numbers in the U.S.A.

RSPA issues station numbers (sometimes referred to as 'retester ID (or identification) numbers') based on the applicant meeting the agency's qualifications. Once issued, the number is valid for five years provided the retest station maintains equipment and personnel at the level observed when the inspection for the ID was performed. A third party, independent inspection agency is charged with performing the applicant inspections.

A retest station must register with the DOT and obtain and hold a valid inspection station number in order to legally perform the hydrostatic retest on scuba cylinders.

When a retest date is stamped on the cylinder (marking), the retest station is certifying that the cylinder meets DOT hydrostatic retest standards, and that the retest station holds a valid identification number, issued by DOT/RSPA. Every shop and cylinder owner should verify that the station where cylinders are being retested in their area, is a duly qualified retest station holding a valid DOT/RSPA station number.

Information about hydrostatic testing and the retest program is found in the Code of Federal Regulations, Title 49. Other documents may outline this program in more detail than found in this Guide. See APPENDIX E.

The above applies to the U.S.A. Canada and other countries may have similar or different standards, requirements, and regulations controlling the use, handling and transportation of high pressure aluminum cylinders. If you are inspecting or operating outside the U.S.A., you need to contact the authorities that regulate scuba cylinders to get: testing, inspection and cylinder certification requirements.

Briefly, the hydrostatic retest is a measure on how much a cylinder will expand when a specified pressure is applied. In our opinion, the most common and safest method is the water jacket method. We would recommend that only a hydrostatic retest station using this method be allowed to test Luxfer Gas Cylinders high-pressure aluminum scuba cylinders.

The cylinder is placed inside of a water jacket or bath (containing water) which is specially sealed. The cylinder is pressurized and the amount of water displaced in the water jacket is measured by a precision method. This amount of water represents how much the cylinder expanded under pressure. Information is then gathered to determine if the expansion of the cylinder complies with DOT regulations. If the cylinder passes, the retester marks the cylinder by stamping into the metal the retest date (see '**markings**')⁶ The cylinder is returned to service for up to five more years, when the retest must be done again.

2. Some scuba divers have been known to have scuba cylinders partially filled with pure oxygen, then having them topped off with air or nitrogen (NITROX). This practice can cause catastrophic failure and loss of life or serious injury. Scuba cylinders, valves and other components are not specifically cleaned for oxygen use. Also, some lubricants used in the industry are not compatible with pure oxygen, or high oxygen air. This could result in a fire or rupture. For additional information, or for guidance on the use of other gasses, oxygen, and various air combinations, contact Luxfer Gas Cylinders.⁷
3. See your distributor or contact Luxfer Gas Cylinders⁷ for information about other available cylinder products.
4. Scuba technicians should ensure that users of scuba cylinders understand the following general guidelines covering the care and maintenance of their Luxfer cylinder. These guidelines can be found in Luxfer's AIR CARE brochure for scuba cylinder owners and free copies can be obtained through Luxfer's website or 800 number.⁷ You can also reprint the following page for Luxfer cylinder owners.

CARE AND MAINTENANCE OF AN SCUBA CYLINDER

ALWAYS:

- check for air leaks with each fill;
- read and understand the caution label (contact Luxfer Gas Cylinders if your cylinder has no legible Luxfer Caution labels);
- keep the threads and cylinder interior dry and free from oil, dirt and other contaminants;
- use Dow 111 lubricant on valves threads (see above);
- fill cylinders with dry air;
- follow the inspection recommendations (see above);
- follow valve manufacturer's installation procedures and recommendations;
- maintain all accessory equipment to your cylinder according to manufacturer's recommendations; and
- fill your cylinder at 300 to 600 psig/minute.

NEVER:

- ever completely discharge cylinder as it can lead to water seeping into the cylinder, except when you're planning to remove the valve;
- overfill aluminum cylinders;
- artificially heat your cylinder;
- fill or partially fill a cylinder with pure oxygen;
- fill a cylinder if it leaks;
- use a cylinder past its retest date;
- use a cylinder that hasn't been visually inspected according to its condition of use (see above);
- over-torque the valve;
- remove, obscure or alter labels or markings;
- use excess Dow 111 lubricant on valve; or
- fast fill (over 1000 psig/minute) your scuba cylinder.

ADDITIONAL GUIDELINES FOR SCUBA CYLINDER USERS:

Maintenance - After each day's use, remove harness assembly (backpack) and boot from cylinder. Wash carefully in clean tap water (fresh water, not sea water) to remove traces of salt, sand and dirt. Rinse cylinder boot thoroughly and clean harness assembly (backpack) of all salt, sand and dirt. Dry all components. Don't reassemble until all components are thoroughly dried. This routine procedure when done conscientiously will extend the life of the cylinder, and significantly reduce the occurrence of corrosion.

Storage - Short term: Tightly close the cylinder valve. Leave some pressure in the cylinder. Secure cylinder and assembly from rolling loose, tipping over or falling. Store at room temperature in a dry place.

Long term: Prior to prolonged storage, the valve should be removed from the empty cylinder. Wash the cylinder internally and externally with fresh tap water, then thoroughly dry (inside and out). Install the valve using a small amount of Dow 111 Lubricant on the threads following the valve manufacturer's recommended valve installation procedures. Replace the O-ring if the manufacturer recommends it. Store valved cylinder at room temperature in dry conditions either upright or horizontal, but *never* inverted, with some positive pressure in the cylinder (not less than 20 psig).

Never store a cylinder near heat or in a place likely to get artificially hot.

Handling - Cylinders should never be dragged, dropped, or roughly handled. When transporting cylinders, take steps to insure that the valve is protected and that the cylinder is well secured. Scuba cylinders should never be allowed to roll around loose, tip or fall during transport. Secure cylinders in a protected position (*never* valve down) so that valve and cylinder will not be subject to damage during transport.

Keep cylinders away from fire and heat sources.

Painting - Retouch damaged paint areas with air drying paint, but if damage has been done to the *cylinder*, have it visually inspected first. Never allow the cylinder to be heated in order to dry or cure paint. Never use caustic or acid paint strippers, burning techniques, or solvents that harm the environment or pose personal health or safety concerns, in order to remove paints from aluminum cylinders. Any chemical used to remove paint from, or to paint a cylinder, should specifically say on the label that it is safe and recommended for use on aluminum surfaces. If the entire cylinder is to be painted, contact Luxfer Gas Cylinders for recommendations.

Inspections - Cylinder should be periodically inspected according to their conditions of use by an experienced, competent visual inspector.

Have your cylinder inspected once every four months if you fill it five or more times per week or if you use your cylinder wherever damage is more likely than in normal diving use, *and/or* your cylinder shows signs of damage or corrosion.

Have your cylinder inspected once every twelve months when it is filled four times a week or less and used under normal conditions *and* is being properly cared for (according to above recommendations).

Labeling - Keep all caution and warning labels on the cylinder. Follow all warning and cautionary recommendations. If your cylinder's labeling has been removed or can no longer be read, contact Luxfer⁷ or your supplier for a Luxfer Caution label.

ADDITIONAL GUIDELINES FOR SCUBA CYLINDER USERS (continued):

Assembly - Be sure all components are compatible with aluminum. For example, the valve should be chrome or nickel plated and the dip tube should be made out of a metal (e.g., brass) plated with chrome or nickel. The dip tube should never be made of plastic. If a stainless steel band is used as a backpack clamp, it should be coated with a suitable plastic to insulate it from the aluminum.

Valve - Choosing the correct valve for your aluminum scuba cylinder is important. The valve metal must not react with the aluminum. Purchase and use valves that advertise compatibility with aluminum. Use valves that are made out of, or plated with, nickel or chrome. Brass, steel, and copper (as well as their alloys) are not compatible with aluminum. If a brass valve is used, it must be plated with nickel or chrome. Nickel and chrome are compatible with aluminum.

Remove and install valves according to the manufacturer's recommendations only. The manufacturer knows where and how to grip the valve for removal and installation, as well as when and how to replace the O-ring. The manufacturer knows the proper torque or tightness for the valve installed into an aluminum cylinder. Only remove valves from cylinders known to be totally empty. A properly working valve on an empty cylinder will allow air to go in as well as out of the cylinder. Test the valve to see that it is working by making sure some air will go into the empty cylinder. If the valve is stuck, don't attempt to remove the valve yourself. Go to an experienced scuba cylinder inspector for help.

Use of thread lubricant. After valve and cylinder threads have been cleaned, apply a small amount of Dow 111 Lubricant to the end of the valve threads. The lubricant will ride up the threads as the valve is screwed in (installed). We recommend only this lubricant since it has proven compatible with cylinders and valves, doesn't add any grease or oil to the cylinder, and is safe to use.

WARNING: *Have your cylinder inspected immediately if any one or more of the following occurs,*

If your cylinder:

- was dropped, was struck, or was in an accident;
- was stored improperly;
- has obvious corrosion since the last visual inspection;
- shows signs of damage (has a gouge, dent, scrape, cut, dig, etc.) since the last visual inspection;
- was stored with water, material or matter inside the cylinder;
- shows signs of exposure to fire or high heat including any one or more of the following:
 - a. Charring or blistering of the paint or other protective coating;
 - b. Melting or charring of the metal;
 - c. Distortion of the cylinder and/or any cylinder accessory;
 - d. Melting of fuse plugs, valve handwheel, valve protector, and/or any other valve component or cylinder accessory;
- is known or suspected to be leaking; or
- is known or suspected of being cracked.

5. There are several kinds of corrosion which differ by what caused the corrosion, as well as the shape and depth of the corrosion. First, refer to the Glossary⁶ for the definition of ‘**corrosion.**’ Next, refer to the Glossary for the various corrosion related words and phrases: ‘**broadspread corrosion, galvanic corrosion, line corrosion, pit corrosion.**’

Corrosion is one of the causes of material loss. Material loss may lead to leaks and ruptures of scuba cylinders. As an inspector, you’re asked to look at the cylinder, both inside and out, for corrosion. When you find corrosion, you are then asked to estimate the depth of the corrosion. In this way, you get an estimate on the material loss being caused by the corrosion.

Broadspread corrosion, sometimes called general corrosion, may be widespread on the cylinder surface, yet pose less of a concern than a corroded pit, which may go deep into the metal. FIGURE 9 shows some of the ways in which pit corrosion may occur. Some types are clear, some pose a special problem for the inspector, since the pit may not go straight down into the metal. The corrosion may proceed at angles and in varying depths within the initial pit. Nonetheless, all types of corrosion must be inspected for how deep it has gone into the metal. See also PHOTOS 11 and 12.

6. As indicated in NOTE 5, corrosion is one of the causes of material loss. Material loss can also be caused by damage (cuts, dents, digs, gouges, scrapes, etc) and some other imperfections.⁶ Once found, the location of the imperfection needs to be identified. Then, its depth needs to be estimated in order to compare with the acceptable limits.

Many of the acceptable limits are from the general limits established by the Compressed Gas Association (CGA), and from Luxfer’s knowledge and experience with the Luxfer scuba cylinder. Luxfer manufactures many different kinds and sizes of scuba cylinders (NOTE 3) and subscribes to the limits recommended by the CGA for scuba cylinders. This we know, from our product line, provides a good standard for cylinder safety.

Location: (Review FIGURES 1 - 4 to familiarize yourself with the various kinds of cylinder crown markings you’re likely to encounter). All scuba cylinders manufactured by Luxfer Gas Cylinders have a mark in the crown indicating to what authority’s specifications the cylinder was manufactured. In the USA, the authority is the Department of Transportation (DOT), and in all USA-marked scuba cylinders you’ll find the initials “DOT” stamped in the crown.

Looking from the top of the cylinder, down on the crown (like in FIGURE 1), put the “D” of the “DOT” at the 12 o’clock position of an imaginary clock. All cylinder imperfections, damages, etc. can then be referenced by this location. If the cylinder was manufactured to another authority’s specifications (e.g., TC), then the first letter of that authority’s identification initials/symbols should be similarly set at the 12 o’clock position.

For instance, if an external corrosion pit was located 90 degrees from the “D” (clockwise — to the right) on the sidewall, then the pit location is described as being at “3 o’clock, outside.” RECORD on THE FORM that the pit was located at “3, outside,” for an even more abbreviated entry. Unless otherwise recorded, imperfections are assumed to be in the sidewall. Thus, other imperfections are recorded as located in the “crown”, “base”, “thread”, “gland” or “face.” If an internal crack in the shoulder²⁰ of the crown was located at 270 degrees from the “D”, then its location is recorded as “9, inside crown.”

Recording the position of all imperfections will help you identify it later during future inspections; help you to show it to the customer at a later time; help you to show it to fellow inspectors and help you to identify its location to Luxfer Gas Cylinders should it become necessary to have a manufacturer’s representative review it. As you inspect a cylinder, take a few moments to identify the location of scuba cylinder imperfections of concern and RECORD them on THE FORM.

Depth Estimates: It is important to next determine if the material loss located makes the cylinder unsafe to return to service, or whether the cylinder should be inspected more frequently. To accomplish this, an estimate of the depth of the imperfection needs to be made.

Before proceeding, the cylinder surface (inside and outside) must be clean enough to see all imperfections. If corrosion is heavy or interferes with the good visual identification of pits, clean it away by one of the recommended cleaning procedures (see more on cleaning, NOTES 13, 16, and 17).

Also, for gouges and digs on the external surface, disturbed, raised or upset metal may need to be filed level with surrounding metal surface for good estimates of their depth. (See Glossary APPENDIX G and Visual Inspection Procedure section 4B. above for the definition of ‘**upset metal**’.)

Practice estimating the depths of depressions, pits, etc. using your pick and the Master Pit Reference Plate from your set of recommended inspection equipment^b as suggested at the end of this note.

See FIGURE 9 for examples of the different kinds of pit shapes and forms. When you probe inside of a corrosion pit, check it out carefully to be sure it doesn’t hide deeper corrosion or corrosion at an angle. Let the pick slip into a pit or surface depression on the outside or inside cylinder surface and estimate the depression’s depth. RECORD it on THE FORM.

When measuring the depth of broadspread corrosion, find the deepest pit within the corrosion or, if no pits are apparent, estimate the deepest part of the corrosion below where the normal cylinder surface would be.

RECORD all depth estimates with the corresponding location and the kind of imperfection.

Practice with the Master Pit Reference Plate: Get a feel for how far the pick enters a Plate depression and how that compares to the known depth of the Reference Plate depression. Lay the Plate flat and run the pick end of the pick/end probe along the surface around the depressions. Let the pick drop into one of the known depth depressions in the Plate. Compare the ‘drop’ you feel with the known depth of the Plate depression. Do this many times, with all the depressions in the Plate.

Next, once the pick is in a Plate depression, try to pull it sideways, out of the depression. Get a feel for how the different depths make it harder or easier to pull the pick out sideways.

Lastly, hold the Plate at an angle so you can’t see the depressions. Slip the pick into, and pull the pick out sideways, from one of the Plate depressions that you can’t see. Repeat this many times. Can you estimate the depth of the unseen Plate depression? Now look at the Plate depression you were practicing on, and check your accuracy. Practice estimating the depth again, changing the position of the Plate and sliding the pick into another ‘unseen’ depression. Repeat this until you feel confident and your accuracy is within one depression standard most of the time.

To restate the process you’ll use on a cylinder: The way to use the pick/end probe for estimating the depth of pits, gouges, digs, etc. is to slide/push the pick over the undisturbed metal surface and then to let it fall or slip into the depression. Move the pick around in the depression, and then, by pulling and pushing the pick in and out of the depression, you can get a feel of the pit’s depth compared to the undisturbed metal surface around the pit. The deeper the pit, the harder it is to get the pick to come out by pulling it sideways. The more shallow the pit, the easier it is to get the pick to pull out sideways and the less noticeable the pick ‘drops’ into the pit when pushing it in.

7. Luxfer Gas Cylinders offers complete customer support for its scuba product line. For any field inspector concerns, questions, or problems, please contact the Customer Service Department as follows:

Luxfer Gas Cylinders
3016 Kansas Avenue
Riverside, CA 92507
Telephone: (909) 684-5110
FAX: (909) 781-6598
www.luxfercylinders.com

Please be ready to identify any cylinder condition (folds, cracks, etc.) on which advice is sought. In some cases, Luxfer will request that condemned cylinders be returned for testing. If we determine it was properly condemned, we will ship a new cylinder at our expense to the owner.

8. See FIGURE 6 for an example of a dental mirror and light. The dental mirror is common and standard whereas there are many different kinds of lights available. For use with a dental mirror, a small, bright penlight works well. The mirror is held to reflect the lit part of the threads or the inside of the crown of the cylinder. See PHOTOS 4 and 20 for examples of mirror positioning.

These photos demonstrate how important the use of such a mirror is for the inspector. The mirror can 'see' areas the eye can't and, at the correct angle, may make a hard-to-see imperfection easy to identify. Careful use of a dental mirror may help determine the difference between a tool stop mark^{P10} and a crack.^{P6}

Almost all imperfections^G require up-close observation that only a mirror and light will allow. There is one important exception, however. Tool stop marks are usually more readily seen from a distance. From a distance they appear as smudges or shadows—an unclear vertical line across the cylinder threads. As your eyes get closer to the thread, a tool stop mark may get more difficult to see, or may even seem to fade.

Looking deep inside long cylinders requires a Light Wand or a high intensity bulb on a long cord. See APPENDIX B for such equipment.

When an imperfection is found, see NOTE 6 for how to record its location and (if required) its depth.

9. Threads of both the cylinder and valve usually trap debris. Using the proper lubricant (Dow 111 Lubricant or equivalent) will even collect some debris. After wiping loose debris from the thread surface, wipe off as much of the old lubricant as you can, with a clean soft cloth. Never grind or press hard when wiping the threads as thread gall^G may occur.

Use an old toothbrush, bottle brush or other medium-hard bristled brush small enough to get inside the neck, to clean the threads. Never use a brush with metal bristles. Dip the bristle end of the brush in some fresh isopropyl alcohol and brush the threads with this solution. Inspect the threads closely to be sure there is no debris left. The threads should be readily visible, showing imperfections clearly.

10. Both finding and estimating the depth of a valley is a challenge. Finding a valley will require careful attention to detail. Lightly run the pick tool over the inside surface of the crown to 'feel' for valleys and depressions. They may be easier to feel than to see, so include this feeling technique along with your visual inspection of the inside surface of the cylinder crown. If you locate one, record its location^G first, then continue. See FIGURE 7 and PHOTOS 16 and 17.

The depth of a valley that is difficult to see or find and that doesn't interfere with thread is not too important. Obvious valley depths can be estimated much like estimating the depth of broadspread corrosion.^G Since the depth of a valley isn't a criteria for condemning a cylinder, the inspector doesn't have to estimate their depth. If you do, be sure to RECORD the depth at the deepest part of the valley (as well as its location).

Valleys that enter into the threaded area of a cylinder are a concern when they ruin threads and reduce the number of continuous full threads below the limits set in Visual Inspection Procedure, section 5B above.

11. A wide variety of things have been found in scuba cylinders by inspectors, including but not limited to: dead insects, dead animals, chemicals, fresh and salt water, corrosion, sand, dirt, and oil. Whereas most of the above may be recognizable from your life experience, there are materials found inside cylinders that you may not be familiar with and these include:

Aluminum Corrosion: Corroding aluminum may be white or black, or any combination of the two (e.g., gray). It is usually powdery after it falls away from the aluminum surface or it may cling to the aluminum surface as a raised, crusty material. With signs of corrosion on the surface, the powdery material of the correct color is usually easily identified as aluminum corrosion. A surprising large quantity of this material can accumulate, especially from cylinders not properly cared for and not inspected frequently.

Aluminum Oxide: Usually a white to gray powdery material. When wet, it will usually form hydroxides (see below). It is not likely to be found, but once other sources of contamination have been eliminated and when there is no visual corrosion, you may find such a powdery substance in the cylinder.

Hydroxides: This material often forms in aluminum cylinders stored with water inside. If conditions are right (poor maintenance and care of the cylinder) a light colored, whitish to gray aluminum oxide may be present which, when moist, becomes gummy. It is an alkaline material (like a strong soap) which may burn the skin.

When contaminating material is found inside the scuba cylinder, it should be removed in order that the interior surface is visible for an accurate visual inspection. (See NOTE 17 for general cylinder internal cleaning procedures.) Save some of the material to show the cylinder owner.

12. Through the decades that Luxfer has manufactured aluminum scuba cylinders, there have been many process/manufacturing changes. The cleaning and preparation of the cylinder inside surface processes have changed over the years, too. Some changes have occurred to improve the product surface, some have occurred to make the manufacturing more environmentally friendly. Whatever the reasons, the various manufacturing processes cause different visual surface effects. These differences are apparent when inspecting the interior of the cylinder.

Over the years, the interior of a just-manufactured Luxfer Gas Cylinders high-pressure aluminum scuba cylinder may have had one of the following appearances:

- Bright shiny white/gray
- Gray to dark gray (almost black)
- Dark gray to brown
- Aluminum gray
- Aluminum gray with darker streaks

As the above surfaces are exposed to use, they may change in appearance. Most get darker as some oxidation of aluminum does occur over time. The recommended cleaning/drying methods¹⁷ may make the surface more aluminum gray.

In all cases, the above list of possible surface appearances is 'normal' for the Luxfer scuba cylinder.

13. The inside surface of scuba cylinders to be visually inspected must be free of any material which hides or prevents the surface from being clearly exposed to the eye. At the beginning of the inspection, removing any loose materials inside the cylinder is the first step. Similarly, removing outside materials so as to be able to properly inspect the exterior of the cylinder is important (cleaning the outside surface is covered in NOTE 16).

After all loose material is removed, any material that can't be removed from a simple washing with soapy water¹⁷ and which impairs seeing the cylinder surface, should be tumble cleaned. Before proceeding, obtain the permission from the cylinder owner to do this procedure.

Once you have the owner's permission, the cylinder should be tumbled as follows:

Tumble the cylinder at 25 to 35 rpm for 10 minutes with a wet detergent aluminum oxide chip combination (recipe given below). Empty cylinder (tumbling chips may be reused and may be strained from the liquid, then rinsed). Rinse the cylinder well with warm tap water (or soft water if the tap water is hard), blow dry (with warm, dry air if available) or steam dry the interior **briefly**.

The tumbling solution/combination is made by adding two to three cups of aluminum oxide tumbling chips to two quarts of soft water. Then add one teaspoon of a liquid dish washing detergent to the cylinder. Swirl or rock cylinder to mix. (Adding the detergent last and to the cylinder will help keep foaming to a minimum). Double up on the ingredients to make a gallon of the tumbling solution/combination, if more volume is needed for large cylinders.

Do not shot blast or use any abrasive cleaners, or abrasive cleaning methods on the interior of a Luxfer cylinder, other than the above recommended procedure.

The above tumbling procedure may be repeated on cylinders which are not clean enough for a visual inspection, or the tumbling may be extended up to 20 minutes on cylinders heavily contaminated.

14. Learning the difference between a crack, scratch, breaks, and a tool stop mark in the threads is important in a visual inspection program. Study the photos for examples. See PHOTO 10 for an example of a tool stop mark which is sometimes seen during thread inspections. Contact Luxfer Gas Cylinders⁷ for further help or answers to your questions. Review the definitions of these terms in APPENDIX G.
15. Occasions arise in a cylinder's life that provide good opportunities for visual inspections prior to the twelve month minimum recommendation. For example, have a visual inspection done whenever the cylinder valve is removed (for any reason) and whenever the cylinder has been completely emptied.
16. The outside surface of a cylinder is cleaned so that the surface is exposed to the inspector's eyes. The surface finish on most Luxfer Gas Cylinders scuba cylinders is a coating of paint. This can also include a clear coating over a brushed cylinder. Luxfer may also supply scuba cylinders to distributors who apply their own coatings. Also, some owners have their cylinder re-coated. Because of all these coating possibilities, there can be no generalized statement concerning Luxfer scuba cylinder external surfaces.

The inspector must be satisfied that the exterior of the cylinder is clean enough to inspect the surface. Sometimes, this may mean removing sand, dirt and a salt residue. This can be done with any clean fresh water source or tap water. You can also use a soap solution made of one tablespoon of hydrocarbon-free liquid dish detergent in one gallon of tap water, followed by many clean rinses, to remove dirt.

If, after cleaning the surface, the coating is seen to be raised or bumpy in places, then it is necessary for the inspector to look below the coating to determine if there is corrosion. Some coatings may be removed in a small area simply by lifting a chip of it away from the surface.

If a paint stripper is to be used, it must *not* be a caustic or acid stripper. Check the label and with the manufacturer to verify that the stripper is suitable for aluminum surfaces. We do not recommend the use of any materials which are environmentally regulated or restricted for health or safety concerns. Any material used must be safe to use on, and compatible with, aluminum.

If the raised paint is due to corrosion, it will most often be easily chipped off for an inspection. If corrosion is found on the exterior, under the coating, then the entire coating should be removed. Get permission from the owner before removing large quantities of coatings. See NOTE 4 for paint touch-up suggestions.

Any repainting of cylinders stripped of paint should be done with air-drying paints compatible with aluminum. Never use heat to dry or cure paints. Heating a cylinder will require that it be condemned and never used again.

Do not shot blast (other than sling type) the exterior of the Luxfer cylinder, or use any abrasive cleaners or abrasive cleaning methods. Any method, which may reduce the metal thickness or create metal loss, should not be used to clean Luxfer scuba cylinders.

17. Luxfer Gas Cylinders aluminum scuba cylinders may never need an internal cleaning, provided they are cared for and maintained according to our recommendations⁴. Occasionally, lubricants may get into the cylinder or organic materials may be trapped, causing odors. Under these circumstances, when the cylinder has been contaminated, an internal cleaning is useful. This cleaning is not connected with the process for removing corrosion or internal contaminants obscuring a visual inspection,¹³ but is a general cleaning guideline for removing offensive odors, lubricants, and light soil:

Moisture and light soil: Steam clean and blow dry.

Oil, grease, lubricants: Clean with a soapy solution (one tablespoon of liquid dish washing detergent to one gallon of tap water (use soft water if your tap water is hard)). Rinse several times with tap water, rinse twice with soft water, steam clean and blow dry.

Odors: Rinse thoroughly with a solution of baking soda (one cup baking soda to one gallon of tap water). Rinse with clean tap water. Then, rinse with a solution of vinegar (one half (1/2) cup of household vinegar to one gallon of clean tap water). Rinse several times with fresh tap water, rinse twice with soft water. Steam clean and blow dry.

Be sure to use Dow 111 Lubricant sparingly when installing valves. (See Visual Inspection Procedure, section 9 above.)

18. Label removal from the coated surface of a Luxfer scuba cylinder should be done so as to not disturb or ruin the coating and the aluminum cylinder. A particularly good physical label removing tool (the Super Scraper) is available from Motsenbocker.^{B&C} We do not recommend the use of chemical label removers.

This page is intentionally left blank.



APPENDICES

APPENDIX A

VISUAL CYLINDER INSPECTOR TRAINING WORKSHOPS

Luxfer recommends that those who want to perform visual inspections on scuba cylinders, obtain training and accreditation from a reputable and knowledgeable source. The guidelines set forth in this document are not meant to replace the experience and knowledge an inspector can obtain from an inspection training course. At this time, we are aware of the following independent source for such training:

Professional Scuba Inspectors, Inc. (PSI)
6531 NE 198th St.
Seattle, WA 98155
(425) 486-2252
www.marinestudio.com/sunpacific/psi
e-mail: psicylinders@msn.com

There may be other training agencies offering visual inspection training courses and materials. We suggest you contact your trade or industry association for further information.

APPENDIX B

INSPECTION EQUIPMENT AND ACCESSORIES

Equipment, tools and accessories referred to in this document may be available from multiple sources listed in APPENDIX C. The purpose of this appendix is to identify and list recommended equipment and accessories. Following each description is a number(s) in parentheses () which is a reference to the sources listed in APPENDIX C.

ITEM DESCRIPTION/USE(S)

Pick/end probe: Extends inspector's eyes and fingers into cylinder to probe imperfections of the interior surface. Looks like a long handled (30 inch) dental pick. Used to estimate depths of corrosion pits and external damages (gouges, digs, scrapes, etc.). (1, 5)

Straight Probe: The long-handled (30 inch) probe extends the inspector's eyes and fingers far into the cylinder, to probe the inside base. This is a straight, pointed-end, thin, stiff metal rod. (1, 5)

Master Pit Reference Plate: A very useful reference disc. This round plate has several machined depressions in it of known depths. Depths should range from 0.01 inch to 0.06 inch, including a 0.03 inch depth to use with this guide. More depths on the reference plate are acceptable. With practice, this plate will give the inspector a sense for estimating imperfection depths in cylinder surfaces. (See the end of NOTE 6 for recommended use and see APPENDIX G Glossary for definition of 'imperfection'). (1, 5)

Dental Mirror: A typical high quality half-inch diameter mirror, placed at the end of a bent probe, commonly used in dental offices. Used here to inspect the thread and internal crown area of the cylinder. The preferred dental mirror is one which offers a 2X magnification of the reflection, manufactured by Grobet File Company of America, part 29.386 (ask for the magnification mirror, same part number). Review the photos to see how indispensable this tool is in viewing hard-to-see areas of the cylinder. See FIGURE 6 for a sample positioning of the mirror when looking for shoulder cracks, and PHOTOS 4 and 7 for thread inspection positioning. (1, 5, 6)

Inspection Light: A small, penlight-like light source (see FIGURE 6). The light is used in conjunction with the mirror. Variations on this theme have proven useful, such as the custom altered Mighty Lite from source 1. (1, 5, 7)

Light Wand: For seeing deep into the cylinder, it is useful to have a light source that can enter the cylinder and go to the base of the cylinder. Consider investing in a wand or inspector's lamp. This can be as simple as a string of white Christmas tree mini-lights on a stiff rod or as elaborate as a high intensity bulb at the end of a flexible cord. (1, 5, 10, 12)

Magna-Lite: Hand-held magnifier with light source. Useful for inspecting the outside surface areas of the cylinder. See FIGURE 5. (5)

Dow Corning 111: Lubricant of choice for installing valves to cylinder. A little goes a long way. See Visual Inspection Procedure section 9. (1, 2)

Small Metal File: A fine metal file is used to remove raised portions of disturbed metal on the exterior of the cylinder. (5)

Work Bench: A steady, well-lit table or bench to bring the cylinder to a comfortable height for external and internal inspections. Cylinder should be braced with blocks or a vise that doesn't damage the cylinder surface. A station to inspect the interior of the cylinder at about knee level to the operator is useful.

Inspection Stickers: The inspector's own design (or ones obtained from an outside source). Sticker should indicate "ACCEPTED" and where the inspection took place. (1, 5)

Old Tooth Brushes: You now have a use for those old toothbrushes you've been throwing out. A medium-firm brush or bottle brush will do just as well when cleaning cylinder threads. Never use brushes with metal bristles. (5)

Isopropyl Alcohol: Sometimes referred to as 'rubbing alcohol,' and is readily available. Read the label carefully to make sure it is isopropyl alcohol. Used to clean cylinder and valve threads.⁹ (5)

Liquid Dish Soap: Hydrocarbon-free soap is used to clean the exterior¹⁶ and interior¹⁷ of dirty or contaminated cylinders. (5)

Air-Dry Paints: To touch up external surfaces opened for inspection (e.g., small area paint removal where corrosion under the coating is suspected), or for touching up gouges, digs, etc. which have removed or disturbed the external coating. Paint must be labeled that it is recommended for aluminum surfaces. (See NOTE 4 for more information about painting as it pertains to the proper maintenance of the cylinder.) (5)

Bowls: Sturdy ones, used to catch water, debris and contaminants found inside cylinders.

Super Scraper: Remove labels physically by slipping this ingenious thin plastic wedge under the label. Useful for removing labels which may hide external imperfections.⁶ (8)

Scotch-Brite Scrubbing Pads: A non-abrasive scrubber for removing stuck-on dirt and debris from cylinder surfaces. (5, 9)

Documents: Customer Release for Cylinder Inspection Form.^E The Scuba Visual Inspection Form; a two-part Form for recording inspection information.^D Previous inspection reports on the cylinder being inspected (if available; or from the inspector's files). (1, 5)

Filing System: Keep records of previous inspections and inspection reports. (5)

Labels: Keep a supply of Luxfer Caution Labels. If the cylinder inspected doesn't have a caution label that can be read, place another caution label on the cylinder before it is returned to service.

Straight Edge / Ruler: A reliable straight edge of metal or wood is needed to test cylinder for some imperfections. A foot ruler with easy-to-read increments is needed to measure some imperfections.

For inspectors who will likely be having to clean the interior and exterior cylinder surfaces of dirt and contaminants, a steam cleaner, dry warm air source, and a soft water source is recommended.

Visual Plus: A non-destructive, eddy current testing device which can detect imperfections in the neck region of scuba and other high-pressure gas cylinders. Visual plus is distributed by Advanced Inspection Technology.^C

For inspectors who will be tumble cleaning cylinders, you will need the following:

Tumbler: A motorized device to slowly rotate the cylinder at speeds of about 25 to 35 rpm. Ideally, equipped with a timing device to shut it off. If not, a loud timer should be included or attached. (3, 10, 11)

Aluminum Oxide Tumbling Chips: Tumbling medium to be combined with soapy water. (4, 10)

Colander: Preferably a plastic vegetable strainer, to catch and rinse the tumbling media for reuse. (5)

Items of general usefulness: Clean dry, soft rags, clip board, pens/pencils, hand-held magnifying glass, bottles/jars with lids or zip-lock bags (to hold debris and contaminants found inside cylinders to show owner what was found).

APPENDIX C

INSPECTION ACCESSORY SOURCES

1. PSI, Inc., 6531 NE 198th St., Seattle, WA 98155, (425) 486-2252.
E-mail: psicylinders@msn.com and www.marinestudio.com/sunpacific/psi
2. Dow Corning 111 Lubricant may be found in your local area by looking up BEARINGS in your Yellow Pages/Phone Book. Contact bearing suppliers in your area to see if they sell it. The lubricant is used in the bearing industry and, if not available from a bearing company near you, they may help you find it. Also available from source 1 above.
3. The tumbler mentioned in APPENDIX B and NOTE 13 can be easily made with some rollers, a motor and timing device. Some operations and hydrostatic retest stations may offer this service to inspectors in their area. Or purchase one from source 10 or 11.
4. Galiso Nuvac, 22 Ponderosa Dr., Montrose, CO 81402, (800) 854-3789.
5. General supply or manufacturing places (local and mail order), such as: hardware store, grocery store, drug store, office supply, printer (stickers), laboratory supply houses, scientific supply sources (e.g., Van Waters & Rogers (800) 999-8974, Baxter Diagnostics Inc. (800) 234-5227, etc.), and local machine shops (picks, probes, 'homemade' Master Pit Reference Plate, Light Wands, tumbler, etc.).
6. Ken's Tool & Supply, (909) 686-2542; Wherever you purchase the dental mirror, ask for the half-inch, 2X mirror manufactured by Grobet File Company of America, part number 29.386. The part number doesn't guarantee the magnification of the mirror. You'll need to ask for the 2X mirror with that part number.
7. PB-2 Penlight, Mel's Industrial Supply, (909) 737-8143. Many office supply stores and hardware stores have such lights.
8. Motsenbocker Super Scraper. Call (619) 581-0222 for your nearest supplier.
9. 3M Corporation product. Check sources listed in source 5 above.
10. Hydro-Test Products Inc., 1-800-225-9488.
11. Global Manufacturing Corp., 1-800-558-1811.
12. ZTC, Inc., 1-800-882-0708.
13. Advanced Inspection Technology, 1220 East Washington St., #24, Colton, CA 92324, (909) 369-0945, fax: (909) 369-7313.

APPENDIX D

SCBA CYLINDER VISUAL INSPECTION FORM

You may want to use the following sample form. Feel free to modify or copy this form. Pre-printed forms are available from PSI and other sources.^{B&C}

Ideally, you may want to print the guidelines for the care and maintenance of the cylinder⁴ on the back of THE FORM.

SCBA CYLINDER VISUAL INSPECTION FORM

Cylinder Owner: _____

Phone: _____ Date: _____

Address: _____

City: _____ State: _____ Zip: _____

I GENERAL

Receipt: With accessories _____

Under pressure/any leaks? _____

II CYLINDER INFO

Markings: Serial Number: _____ Service Pressure: _____

Gov't. Specification: _____

Original Hydro: _____ Last retest: _____

Visible conditions/reason for inspection? _____

Inside contaminants/materials found/odor: _____

III EXTERIOR

Any bulges, or bows noted? _____ Where? _____

Any dents, cuts, digs, gouges, scratches? _____ Where/depth/length: _____

Corrosion? _____ Kind? _____

Where/depth/length: _____

IV THREADS

Gall? _____ Known leaks? _____ Good thread count, starting from top: _____

Good threads needed? _____ O-Ring gland/face condition: _____ Cracks? _____

Where/describe: _____ Valleys into threads? _____

Where? _____ Thread loss due to valley? _____

How many threads affected? _____ General appearance: _____

V INTERIOR

Any cleaning required? _____ Kind? _____ Crown cracks/folds found? _____

Where? _____ Corrosion? _____ Kind? _____

Where/depth/length: _____

VI CYLINDER STATUS

Accept/Condemn: Explain: _____

Condemn how? _____

Remarks: _____

Inspector's signature: _____ Location: _____

Inspection Date: _____

APPENDIX E

CUSTOMER RELEASE FOR CYLINDER INSPECTION FORM

You may want to consider using the following sample form. Feel free to modify or copy this form. Other, pre-printed, forms are available from PSI and other sources.^{B&C}

CUSTOMER RELEASE FOR CYLINDER INSPECTION FORM

To Our Valued Cylinder Owner and Customer:

Thank you for considering us for your high pressure scuba cylinder visual safety inspection. The regular visual safety inspection of your scuba cylinder is part of its routine care and maintenance. With proper care, maintenance, regular visual inspections and hydrostatic retesting (retesting is done every five years), your cylinder will provide you a long, safe and satisfactory service.

Visual safety inspections need to be done on your aluminum scuba cylinder to assure its continued safe service. The frequency of these inspections depends upon the kind of use, care and maintenance your cylinder gets. The more often it is used, the worse its care, maintenance and handling, the more frequently it should be inspected.

Your cylinder should also be inspected before further use whenever it is known to have been exposed to temperatures over 350°F, been in an accident, known or suspected to be leaking, dropped, fell, was struck, has obvious corrosion since the last visual inspection, has a gouge, dent, scrape, cut, dig or, in any way, has been damaged since the last visual inspection, or was stored with water, material or matter inside the cylinder.

Your cylinder should not be used if it is, or is suspected to be, leaking.

Your cylinder should be inspected once every twelve months, or more frequently in certain cases. The visual inspector can help you decide how frequently your cylinder should be inspected. If it is time, or, you suspect or have any concern about the general condition of your scuba cylinder, a visual inspection by an experienced visual inspector is needed.

The visual inspection is a safety check on your cylinder and the inspector performing it wants to make sure that your scuba cylinder is safe for continued service. If, during the inspection, a cylinder condition exists which would make your scuba cylinder unfit for continued service, it will be necessary to condemn and to render your cylinder unusable. The condemned cylinder, valve, and accessories will be returned to you with an explanation of the condition found. By signing below, you agree to this process which may render your scuba cylinder unusable in the future.

I, _____ (print owner name or name of authorized owner representative), have requested that the scuba cylinder identified by the serial number:

_____ be visually inspected.

I agree, as a condition of having this visual inspection, that the cylinder may be disabled and/or rendered unusable if it does not meet the accepted standards of quality established by the manufacturer for continued service. I will receive a written report of any and all conditions which caused the scuba cylinder to fail the inspection and to be condemned. Also, I will have the condemned cylinder, accessories, components, and valve returned to me.

Owner (or representative's) Signature: _____

Date of signing: _____

Witnessed by (inspector or store rep.): _____

APPENDIX F

FURTHER REFERENCES AND INFORMATION

For further information and reading, we would suggest reviewing:

CGA Document C-6.1; "Standards for Visual Inspection of High Pressure Aluminum Compressed Gas Cylinders," by
Compressed Gas Association, Inc.
1725 Jefferson Davis Hwy, Suite 1004
Arlington, VA 22202-4100
(703) 412-0900

CGA Document P-5; "Suggestion for the Care of High Pressure Air Cylinders for Underwater Breathing," by
Compressed Gas Association, Inc.
(above address and phone)

Other CGA Documents: C-1 (Hydrostatic Testing information); and, C-7 (Compressed Air information)

Department of Transportation, Title 49 Code of Federal Regulations (CFR) Parts 100-199, Rev. 10/93 and, Parts 170-179, from
U.S. Department of Transportation
Superintendent of Documents
U.S. Government Printing Office
Washington, D.C. 20402

Inspecting Cylinders, by William L. High.

Available from:

PSI, Inc.

6531 NE 198th St.

Seattle, WA 98155

(425) 486-2252.

E-mail: psicylinders@msn.com

APPENDIX G

GLOSSARY OF TERMS

These terms are defined and described as they relate to Luxfer high pressure scuba aluminum cylinders.

acceptable with notation: A class of cylinder which is fit for service, but which has some imperfection(s) that pass the visual inspection procedure. This cylinder will require more frequent inspections to monitor the imperfection(s). Owners should be advised when the cylinder should be replaced and advised on how they can prevent the condition(s) which caused the cylinder to fall into this class.

aluminum alloys: Scuba cylinders manufactured from aluminum are actually produced from a variety of aluminum mixtures. These mixtures are called alloys. An alloy called 6351 was used by Luxfer up to and including 1988. Since 1989, Luxfer uses an alloy called 6061. No matter what alloy your Luxfer cylinder is made from, regular visual inspections and hydrostatic retesting are part of the proper care and treatment of a Luxfer scuba cylinder.

base: The bottom, flat portion of the cylinder. See Figure 11.

bow: A cylinder exhibiting a curved feature. On one side, the cylinder may appear to be raised, as in PHOTO 18. On the other side, the cylinder may appear to have a depression, as in FIGURE 11. Such a cylinder usually has a peculiar, un-smooth pitch when it rolls on a flat surface. Also known as “banana”.

broadspread corrosion: General corrosion, usually irregular, covering a relatively large area and causing material loss. May or may not have random pitting and is sometimes difficult to see when it is uniform. Also called general corrosion, or widespread corrosion.

bulge: A swell or bend outward of metal. A protuberance which is easy to see using a straight edge. See Figure 10.

condemn: To remove from service and make unfit for future use. The Luxfer Scuba Visual Inspection Procedure indicates *when* to condemn a cylinder and, in Section 8C., indicates *how* to condemn a cylinder.

continuous full thread: Uninterrupted, unbroken thread with a sharp peak and without imperfections. (See **thread** and **imperfection**).

corrosion: The simple oxidation of aluminum metal or galvanic action. Action of chemicals, water, or sea water may produce corrosion if the cylinder isn't kept clean and dry, or taken care of properly. Corrosion caused by galvanic action often comes from the exposure of the cylinder to other metals. Copper, brass and stainless steel contacts are significant sources of galvanic corrosion.

Most valves are brass, plated with an inert metal (e.g., chromium or nickel), however if the plating is broken, incomplete or penetrated, the valve brass in contact with aluminum may cause galvanic corroding of the aluminum. This type of galvanic corrosion occurs primarily around the valve connection area, but may spread throughout the cylinder interior.

Stainless steel comes into contact with the aluminum cylinder when steel accessories, straps, bands, etc. remain in contact with uncoated or unprotected aluminum surfaces.

Corrosion leading to material loss may cause cylinder leaks and ruptures.

Corrosion of aluminum will appear as a white-roughened or discolored area, with a loose or crusty white deposit sometimes associated with the corrosion. Estimating the material loss due to the corrosion, and condemning cylinders with severe or unacceptable corrosion is an important function of the inspection procedure. See **broadspread corrosion**, **line corrosion**, and **pit corrosion**. Proper care and maintenance⁴ will prevent corrosion.

crack: A split or fracture (usually jagged) in the metal causing an open and often fine fissure which may cause leaks if permitted to develop. Carefully inspecting for cracks is an important function of the inspection procedure. Condemn all cylinders with cracks before any leak or rupture can occur. See also, **thread cracks**.

cross threads: When the threaded area appears to have two different sets of threads. This can be caused by installing the wrong valve (threads on valve don't match the threads in the cylinder) or by installing a valve crookedly. When a valve is screwed in crookedly, the valve threads may 'cut' new threads in the cylinder. When the wrong valve goes in, the valve threads can 'cut' a new set of threads in the cylinder. The new set or partial set of threads are there, in addition to the set of threads machined there by Luxfer. The visual effect is to make the threaded area appear to have two sets of threads.

crow: The dome-shaped top portion of the cylinder which includes the distance between the top facing down to where the sidewall begins. The aluminum in this area is thicker than in the sidewall. See FIGURE 5.

cut: An incision or gash associated with some loss of wall thickness, usually made by a sharp object.

cylinder: For the purposes of this Guide: A single-piece tank made of aluminum alloy material manufactured by Luxfer Gas Cylinders to contain air under high pressures for use in a self contained underwater breathing apparatus. The cylinder is only the tank portion of the assembly and does not include any attachments.

dent: Imperfection of the cylinder caused by a blunt object in such a manner that the wall suffers no material loss but shows an indentation. Dents up to one sixteenth of an inch deep can be tolerated when the major diameter of the dent is two inches or more.

A small diameter dent upsets the metal in such a way as to make it more unsafe than a large diameter dent. Small diameter dents cause distortion of the metal at a sharp angle. The sharp angle weakens the metal. A large dent, however, has caused the metal to be distorted at a gradual angle. The gradual angle is less of a concern. That is why a small diameter dent is cause for condemning a cylinder, but a larger diameter dent is not. Also, a measure of the angle is how deep the dent goes. The deeper the dent, the sharper that angle. Since it isn't easy for the inspector to measure the angle of the dent, criteria for condemning dented cylinders is based upon what you can easily measure: depth of dent and the diameter of the dent.

The condemning criteria is thus: Condemn cylinders with dents over one sixteenth of an inch in depth; condemn cylinders with any depth dent if the dent diameter is under two inches. See PHOTO 1.

digs: An imperfection associated with some loss of wall thickness (material loss) usually caused by a sharp object, leaving a gouge-like short, wide cut.

DOT: Department of Transportation. A U.S.A. federal agency regulating interstate trade within the United States of America. Wherever references to the DOT are made, the inspector and reader of this document should be aware that other countries may have similar or differing regulations. If operating outside the U.S.A., the inspector must be aware of regulations in the country the cylinder is used, which govern cylinder safety, care, handling, use, certification and inspection. See APPENDIX F.

face: The topmost place of the cylinder, parallel with the base, above the threads, which may touch the bottom of an installed valve. See FIGURE 5.

fast fill: A Luxfer aluminum scuba high pressure cylinder should never be fast filled. We recommend filling rates for scuba cylinders between 300 to 600 psig per minute. A fast fill is any filling rate 1000 psig for scuba cylinders per minute or more.

fold: The place where two metal flows meet in such a manner as to create a sharp, visual groove. The groove of the fold will always be along the length of the cylinder and usually in the crown area. See FIGURE 8 and PHOTOS 14 and 15. Compare this to **valley**.

Form, The: The Scuba Visual Inspection Form^D or any form used to record cylinder information, owner information, the inspection date and results, and the inspector's name and findings.

full thread: A sharp thread which is continuous for one complete turn (360°) around the neck, without cracks, nicks, or distortions interrupting the thread.

gall: An imperfection in the metal's surface including a scratch, small gouge, or raised metal areas. Generally, gall in scuba cylinders is caused in the thread area. See **thread gall** for more detailed information.

galvanic corrosion: Corrosive action caused by an electric current. Sometimes the electric current can be caused by the presence of chemicals or differing metals. An electric current is often formed between aluminum and copper (and copper alloys, like brass), and aluminum and stainless steel. Brass valves must be properly and thoroughly plated with metals which don't form such an electric current (e.g., chrome and nickel). Keep uncoated steel accessories (straps, bands, etc.) from coming into contact with uncoated/unprotected aluminum. See **corrosion**.

gouge: An imperfection associated with some material loss usually caused by a sharp object leaving a wide and usually deep trough in the metal. See PHOTO 2.

government specification: A government's requirements for a cylinder which is usually included in the cylinder marking or on a cylinder label. Each country may have their own specification, or, they may accept the U.S.A. DOT specification. Within the U.S.A. the government specification of an aluminum scuba cylinder may be "DOT-3AL" for example, or "DOT-E6498." See FIGURES 1 - 4 for U.S.A. examples.

hazardous service conditions: Cylinders used wherever damage is frequent and/or when the care and maintenance of the cylinder is poor (see NOTE 4); and cylinders in service under unusual circumstances or hazards, such as a cylinder in service where it might be cut, gouged or scraped in its use. These cylinders must be inspected once every month.

heat effects on aluminum cylinders: Metals (e.g., iron/steel and aluminum) change properties when exposed to high temperatures. Aluminum cylinders exposed to fire, arc welding, ovens, furnaces and other heat sources will become easier to rupture. Aluminum cylinders known to have been exposed to heat sources over 350°F (175°C) are unsafe and must be condemned and removed from service. If you suspect a cylinder has been heated to temperatures between 265°F (130°C) and 350°F (175°C) it must be hydro-statically retested before further use. At no time should a cylinder be heated in order to cure or remove paint. See PHOTO 13.

heavy service conditions: Cylinders being filled or ‘topped off’ five or more times per week; rental cylinders in use during ‘off-season’ times; and cylinders used wherever damage is more likely than in normal use or where the care and/or maintenance is slightly below recommended care⁴ are cylinders in heavy service. These cylinders must be inspected once every four months or less.

high-pressure scuba cylinder: Used in this Guide to refer to scuba cylinders manufactured by Luxfer Gas Cylinders to hold air pressures of 1800 psig or more. Other authorities or industry criteria define “high-pressure” as any pressure over 500 psig.

hydrostatic test: A pressure test of the cylinder using a water jacket. The U.S. Department of Transportation (DOT) requires that this test (called a retest) be done on every cylinder every five years by a hydrostatic retester, duly authorized by the Research and Special Programs Administration. See NOTE 1 and APPENDIX F.

hydrostatic retest date: A date, consisting of the month and year, when the hydrostatic retest was performed, after its original manufacturer’s hydro test date. A cylinder should have such a retest date every five years or sooner from the manufacturer’s first hydro test date. See NOTE 1 and APPENDIX F.

imperfection: Used in this guide, it means any visual defect in the cylinder (including thread area). This includes, but isn’t limited to: corrosion, damage (cuts, digs, gouges, scrapes, dents, etc.), cross threads, cracks, bulges, bow, folds, valleys, tool stop marks, etc. Not all imperfections are material losses and may not pose a cylinder safety concern (e.g., bow, and tool stop marks). Each imperfection that does pose a cylinder safety concern is discussed in the Guide, which identifies acceptable limits that can be measured or estimated (e.g., pits), or condemnable features (e.g., a thread crack).

isolated pit corrosion: Pit corrosion, when the pit is alone or separated from other corrosion pits. See **pit corrosion**. See PHOTOS 11 and 12.

line corrosion: Pit corrosion occurring along a line. When pits are so close that they merge, or, from a short distance, appear to be a single corrosion along a narrow to broad line, the effect is called **line corrosion**. Cylinders left with water or sea water inside and then stored on their side often exhibit line corrosion where the water’s edge touches the cylinder wall. Line corrosion is sometimes seen where the cylinder boot may trap moisture at the end coming into contact with the cylinder. Line corrosion is particularly detrimental to the safety of an aluminum cylinder. Follow condemning guidelines carefully. Proper care and maintenance will prevent line corrosion.

markings: The words, letters, numbers and symbols stamped into the aluminum cylinder. Manufacturing markings include cylinder information (date manufactured, date first hydro tested, cylinder type, service pressure [in psig or bar or both, serial number, etc.]). Other markings include the hydrostatic retest date(s) and markings authorized to be added by the DOT. See FIGURES 1 - 4.

material loss: The removal of aluminum metal by corrosion or from physical abuse. The loss of material (aluminum) from any part of the cylinder is one of the most important concerns of cylinder safety. One of the reasons for regular and timely visual inspections, as well as inspections following a known condition (see under FREQUENCY in Visual Inspection Procedure section I.D.) is to condemn cylinders which suffer unacceptable material loss. Material loss can also occur when owners (with good intention) try to sand a cylinder, or blast it with material to make it shiny or to restore a luster to the aluminum cylinder surface. These activities are not recommended, as surface treatments may result in sufficient material loss to cause leaks and ruptures. See PHOTO 2.

metal alloys: Over the years, different metal mixtures have been used to manufacture scuba cylinders. These metal mixtures are called alloys. Different alloys of steel and aluminum have been used by many different manufacturers. Generally, when one considers an 'aluminum alloy' the majority of the metal mixture is aluminum. See **aluminum alloys**.

metal distortions: During the manufacturing process, some aluminum metal may not flow smoothly, causing sections or areas to form ridges, valleys, folds, and misshaped deviations from the normal smooth and uniform metal. These manufacturing imperfections may generally be termed **metal distortions**. See PHOTOS 3, 14, 15, 16 and 17. See **fold, imperfection, and valley**.

neck: The top portion of the crown, containing the threads, face and O-ring gland. See FIGURE 6.

normal service: A scuba cylinder in normal service under 'average' diving conditions, is well cared for, handled, and maintained according to guidelines in NOTE 4. These cylinders are *not* subject to frequent use (more than four fills per week), nor are they subject to conditions likely to damage them (e.g., diving in confined spaces where imperfections in the cylinder are likely to occur). The normal service cylinder should be inspected every twelve months or less.

O-ring: The gasket placed between the cylinder neck and the valve, forming an air-tight seal. Each valve manufacturer specifies the kind of O-ring to use with the valve as well as its proper installation. Some manufacturers will recommend that the O-ring be replaced whenever the valve is removed. Be sure to follow the valve manufacturer's suggested procedures for O-ring replacement and installation.

O-ring gland: The top portion of the cylinder in the neck which is cut into the aluminum to fit the O-ring. Also referred to as a "seat." Usually a depression in the metal just below the face into which the O-ring fits. The installation of the valve squeezes the O-ring to press against the bottom and side of the gland to make an air tight seal. See FIGURE 6.

pit: A hole or cavity in the metal of a cylinder. Usually caused by corrosion or a sharp object. The pit may or may not be 'straight.' Other possibilities include the many types of corrosion paths outlined in this procedure and the kinds of pit formations shown in FIGURE 9. Since not all pits are identical in shape, the inspector should take a few moments to inspect or probe the pit to get an idea of its overall shape and profile.

pit corrosion: Corrosion which makes a pit. Pit corrosion is particularly detrimental to the safety of an aluminum cylinder. Its depth and shape should be the primary concern of a good inspection, since pits beyond certain depths may render the cylinder unsafe. See PHOTOS 11 and 12. See FIGURE 9. Proper care and maintenance prevents pit corrosion.

psig: An acronym pressure parameter for a gas, standing for pounds per square inch gauge of a gas. Some use “psi” which is “pounds per square inch” but in this guide, since all references are to gas pressures, the more specific and accurate acronym, “psig” is used. Sometimes written “p.s.i.g.” The ‘gauge’ portion references the pressure gauge used to measure the pounds per square inch.

RSPA: Research and Special Programs Administration agency within the U.S.A. DOT. For their function related to scuba cylinders, see NOTE 1.

scrape: To rub with something rough or sharp causing a scuff abrasion and/or scratches. The Super Scraper by Motsenbocker, when used properly, slides along the surface of the cylinder without causing any scrape damage to the cylinder surface (see APPENDICES B and C).

shoulder: The top part of the cylinder from the sidewall to the neck. Most of the crown portion, except for the threaded area. See FIGURE 5.

shoulder cracks: Splits or fractures in the metal, in the top part of the cylinder. See PHOTO 20.

sidewall: The straight smooth portion of a scuba cylinder between the base and the crown. The metal thickness is uniform in this region.

stamped markings: See **markings**. For examples of Luxfer stamped markings used over the years, see FIGURES 1 - 4.

stripped thread: Threads which have been removed, or torn.

tap: A tool to machine threads into a metal. See **tool stop mark**.

thread: The top portion of the cylinder, in the neck, which contains a fine helical filament of metal which meshes with the same of a valve. See FIGURE 5, PHOTOS 4 - 10, and 19.

thread cracks: A split or fracture in the threaded portion of the cylinder. It is usually jagged. See PHOTOS 6 - 9. Not to be mistaken for a “tool stop mark.”

thread gall: Imperfections in the threaded area caused by many possible physical abuses. Thread gall is usually caused when inappropriate, unclean, deformed, damaged or improperly lubricated threaded items (e.g., valves) are forced (screwed) into the cylinder thread. When debris in the cylinder thread or debris on the valve thread is ground into the cylinder thread such as when the valve is installed, gall will often occur. Sometimes, even a clean debris-free thread surface can be galled by valve threading when installing the valve without a small amount of lubrication (see Visual Inspection Procedure Section 9). Threads too large, improperly sized, damaged or deformed, if forced into a cylinder’s thread may cause gall, if not ruining the cylinder’s thread. See **gall** and **cross threads**.

tool stop mark: When the tool (tap) is stopped, after machining threads in metal, there is occasionally a faint, shadowy line left on the thread. Sometimes called a “tool mark” or “tap stop.” The line is straight, passing down through most or the entire thread area. The tool stop mark doesn’t affect the quality, safety or performance of the cylinder or thread area. Without accurate and careful inspection, the tool stop may appear to be a crack. The visual inspector must learn the difference between a tool stop mark (something which doesn’t affect the safety or quality of the cylinder) and a crack (something which may cause the cylinder to leak or rupture). See PHOTO 10.

upset metal: Metal which has been pushed or moved to rise above the regular surface of the metal around it. When aluminum is gouged, scraped, etc. some of the metal, at the edge of the damage, may be raised or set higher than the unaffected metal in the vicinity. In general, the raised or upset metal may be filed and smoothed to the regular surface, so an accurate depth measurement of the imperfection can be taken. Care must be taken so as to not remove metal which is part of the wall thickness in the original design of the cylinder. See **material loss**.

valley: The place between two metal flows which meet in such a manner as to create a shallow and smooth elongated depression. The valley will always be along the length of the cylinder and usually in the crown area. See FIGURE 7 and PHOTOS 16 and 17. Compare this to **fold**.

valve: The control device installed into the threaded opening of a cylinder to restrain and manage the compressed air. Various manufacturers make valves and accessories for scuba cylinders. Brass and/or copper alloy valves should not be used in aluminum cylinders unless they have been thoroughly and properly plated with chrome or nickel so that the brass and/or copper doesn’t come into contact with the aluminum. See **corrosion** and **galvanic corrosion**.

visual inspection procedure: A procedure primarily relying upon the sense of sight to examine, investigate and observe the condition of a cylinder. The procedure in which this glossary appears qualifies as a visual inspection procedure for Luxfer Gas Cylinders, high-pressure, aluminum scuba cylinders.

This page is intentionally left blank.



FIGURES

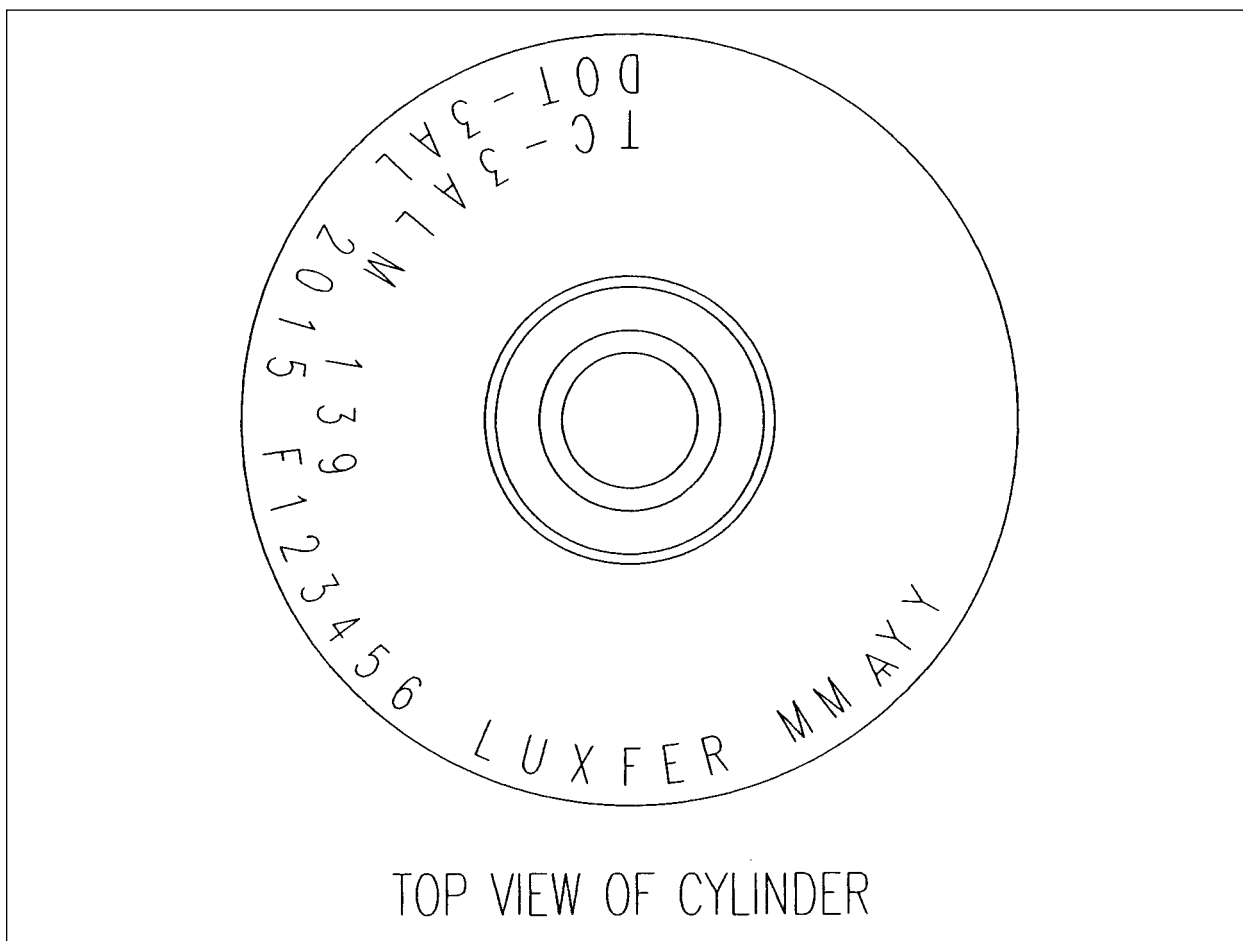

FIGURE 1.

Interpretation

Bottom Row

01. U.S.A. Governmental Specification:
02. Service Pressure (p.s.i.g.):
03. Serial Number:
04. Manufacturer:
05. Original Hydro Date with Testing Agency Stamp:

Marking Example

DOT-3AL
2015
F123456
LUXFER
MM YY

Top Row

01. Canadian Governmental Specification:
02. Service Pressure (bar):

TC-3ALM
139

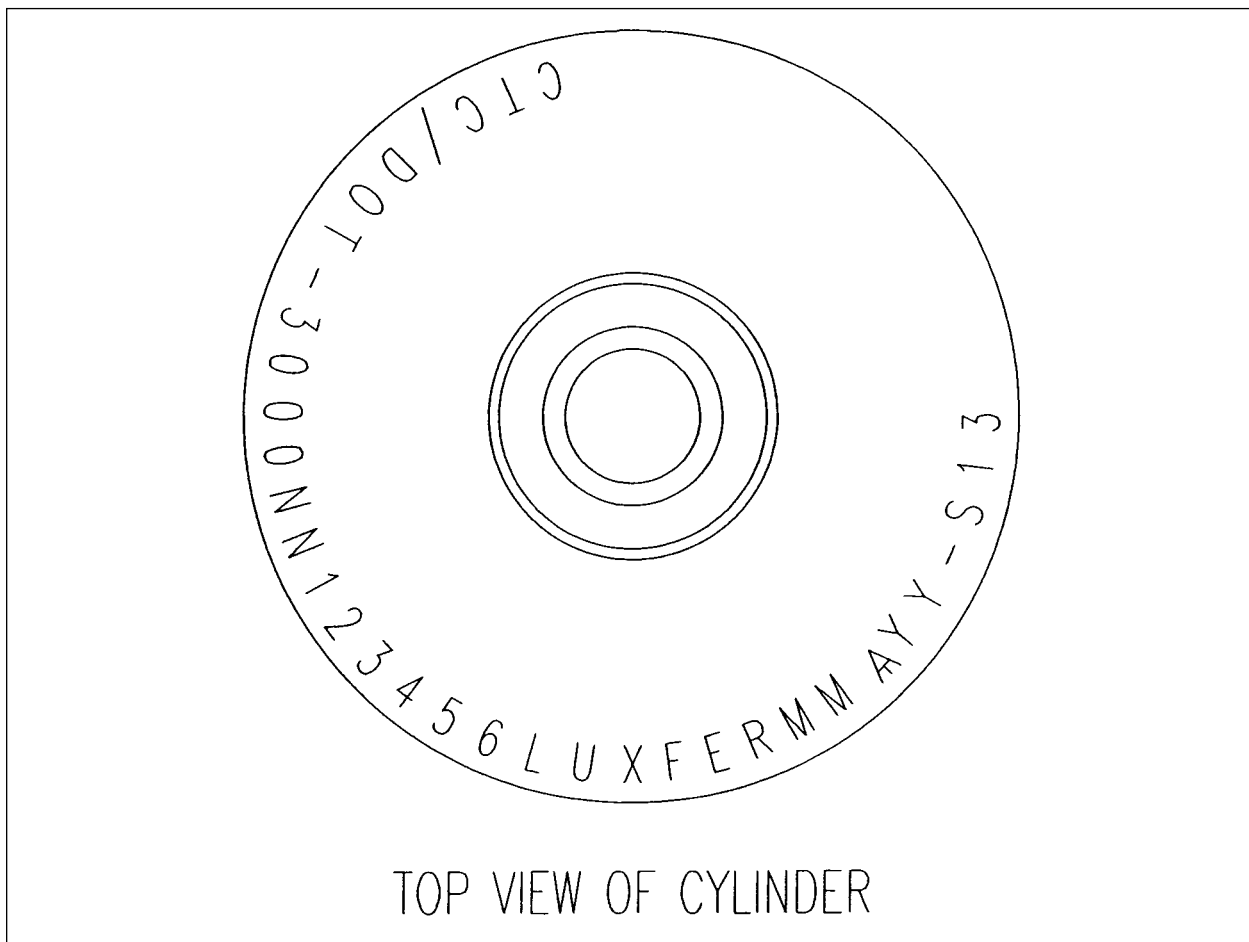

TOP VIEW OF CYLINDER

FIGURE 2.

Interpretation

Marking Examples

Bottom Row

- | | |
|---|-------------|
| 01. U.S.A. and Canadian Governmental Specification: | CTC/DOT-3AL |
| 02. Service Pressure (p.s.i.g.): | 3000 |
| 03. Serial Number: | NN123456 |
| 04. Manufacturer: | LUXFER |
| 05. Original Hydro Date with Testing Agency Stamp: | MM YY |
| 06. Luxfer U.S.A. SCUBA cylinder type: | -S13 |

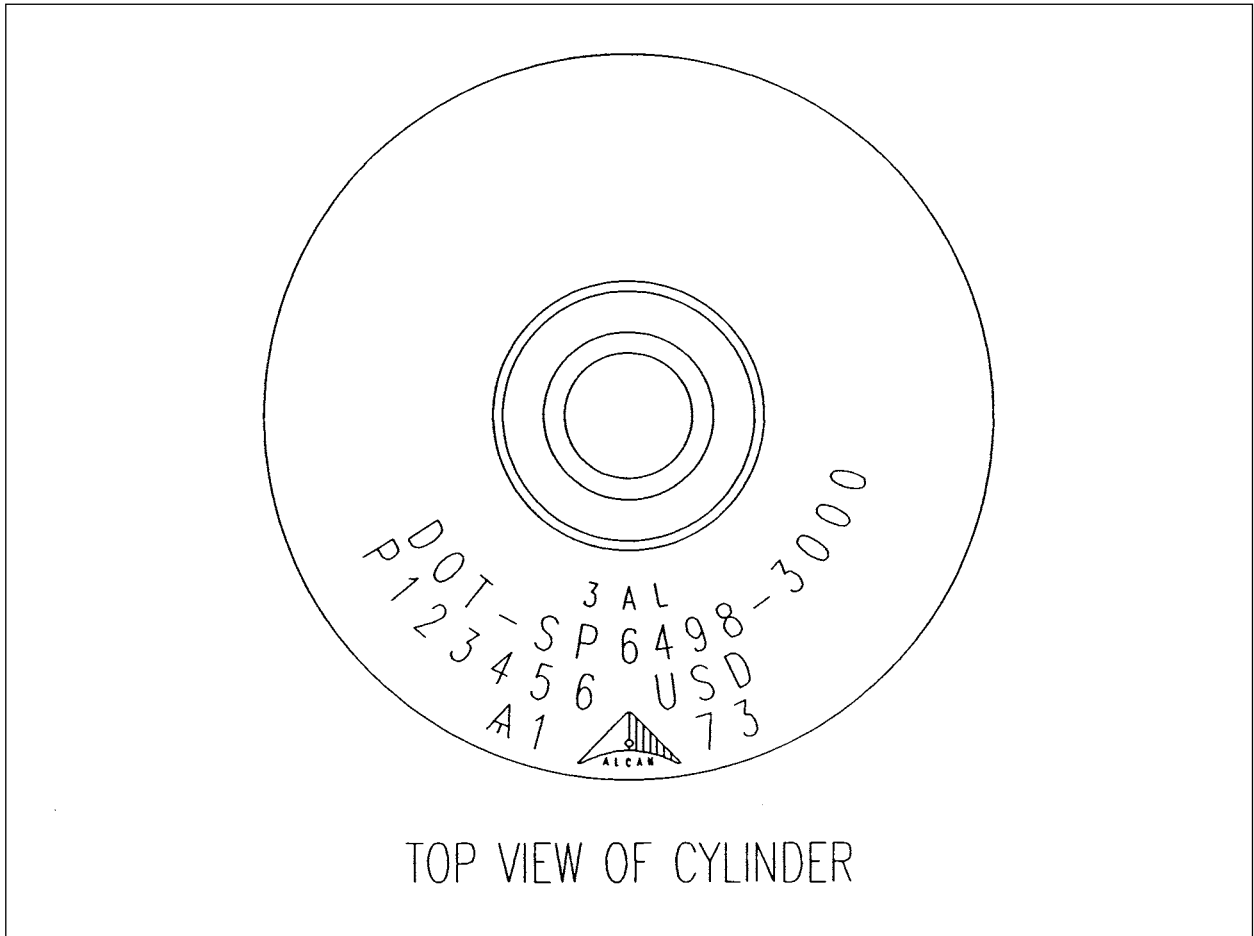

FIGURE 3.

Interpretation

Marking Examples

First Row

- 01. Testing Agency Stamp:
- 02. Original Hydro Date with Manufacturer Stamp:

MMALCANYYY

Second Row

- 01. Serial Number:
- 02. Customer:

P123456
USD

Third Row

- 01. U.S.A. Governmental Specification:
- 02. Service Pressure (p.s.i.g.)

DOT-SP6498
-3000

Fourth Row

- 01. Restamp U.S.A. Governmental Specification Stamp: 3AL

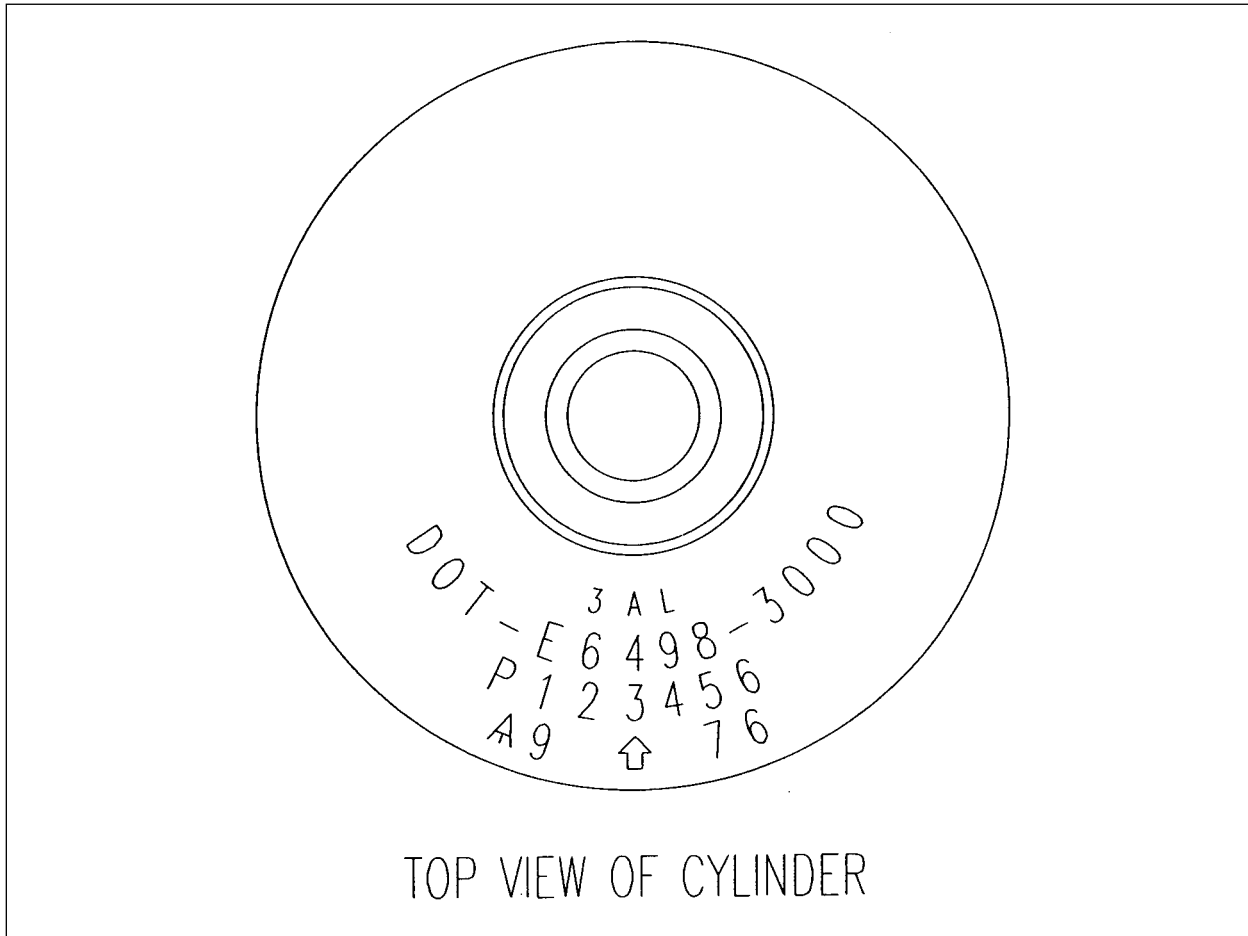

TOP VIEW OF CYLINDER

FIGURE 4.

Interpretation

Marking Examples

First Row

- 01. Testing Agency Stamp: .
- 02. Original Hydro Date with Manufacturer, Luxfer U.S.A., Stamp: MM YY

Second Row

- 01. Serial Number: P123456

Third Row

- 01. U.S.A. Governmental Specification: DOT-E6498
- 02. Service Pressure (s.p.i.g.): -3000

Fourth Row

- 01. Restamp U.S.A. Governmental Specification Stamp: 3AL

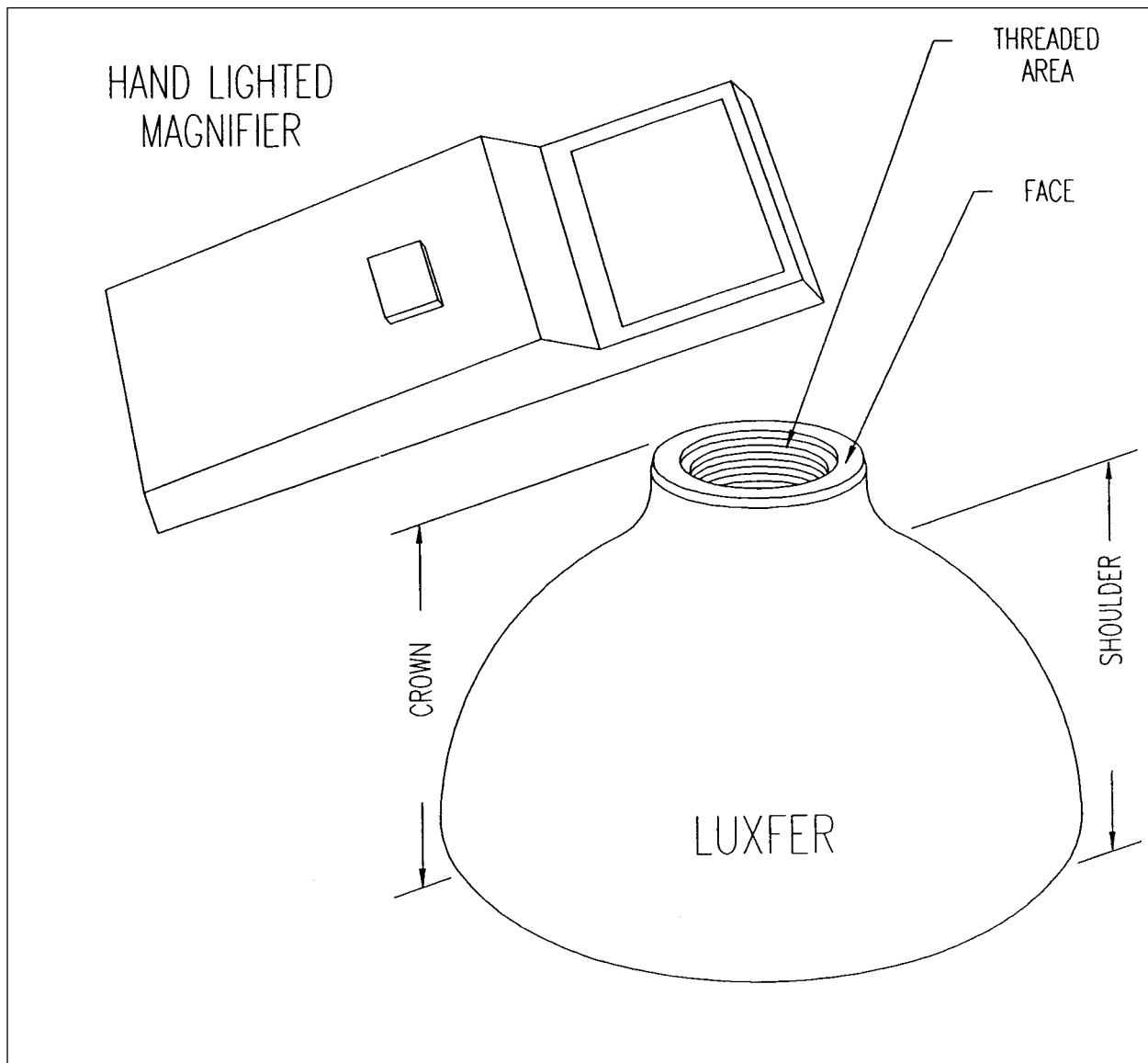

FIGURE 5.

FIGURE 5 shows a MAGNA-LITE Model #1502, 3 power wide-angle, hand-lighted magnifier and a Luxfer USA Limited crown section.

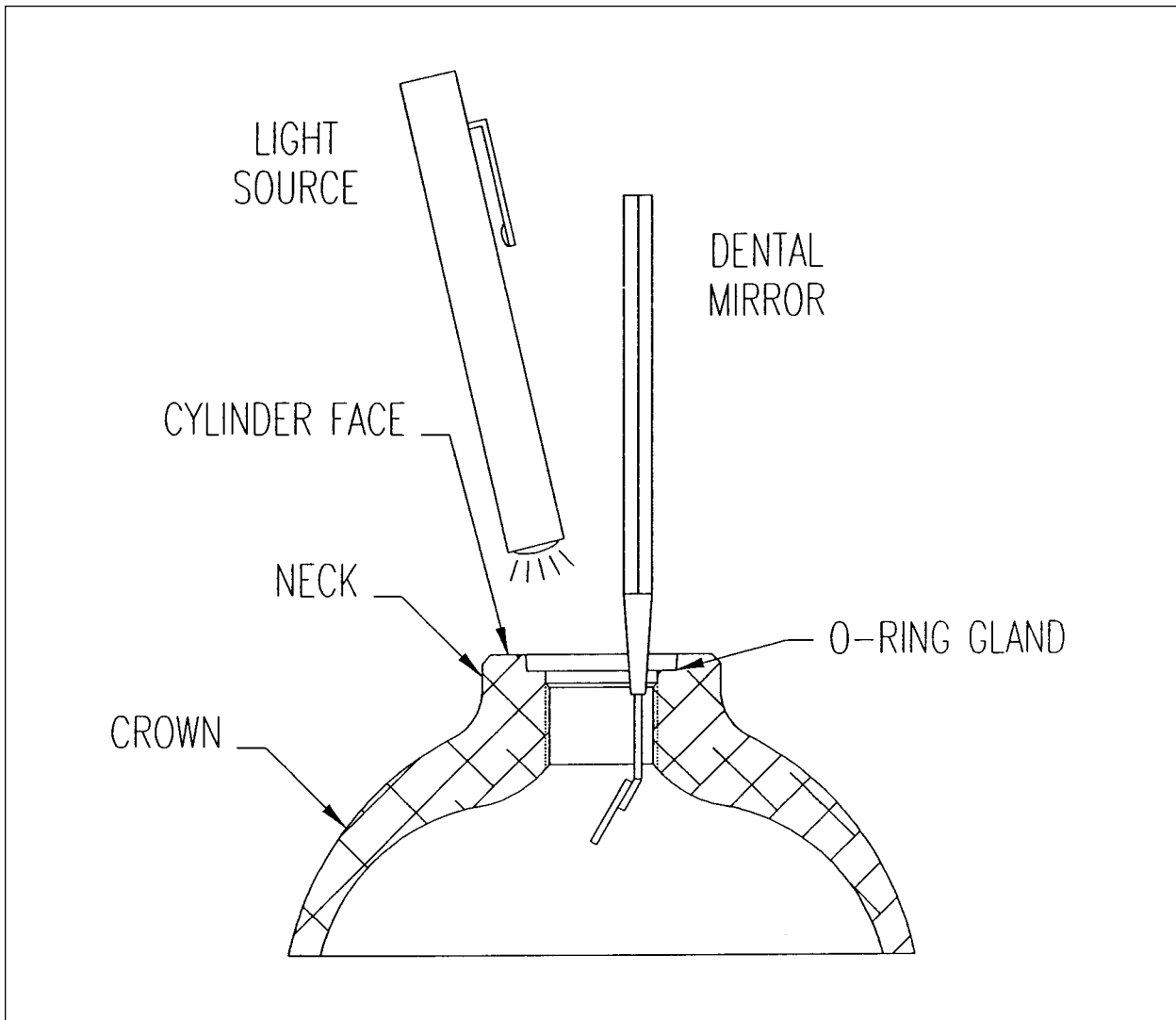

FIGURE 6.

Dental mirror in position with a light source to adequately illuminate the interior of the crown area of the cylinder which allows the user to perform a successful inspection. See PHOTO 20.

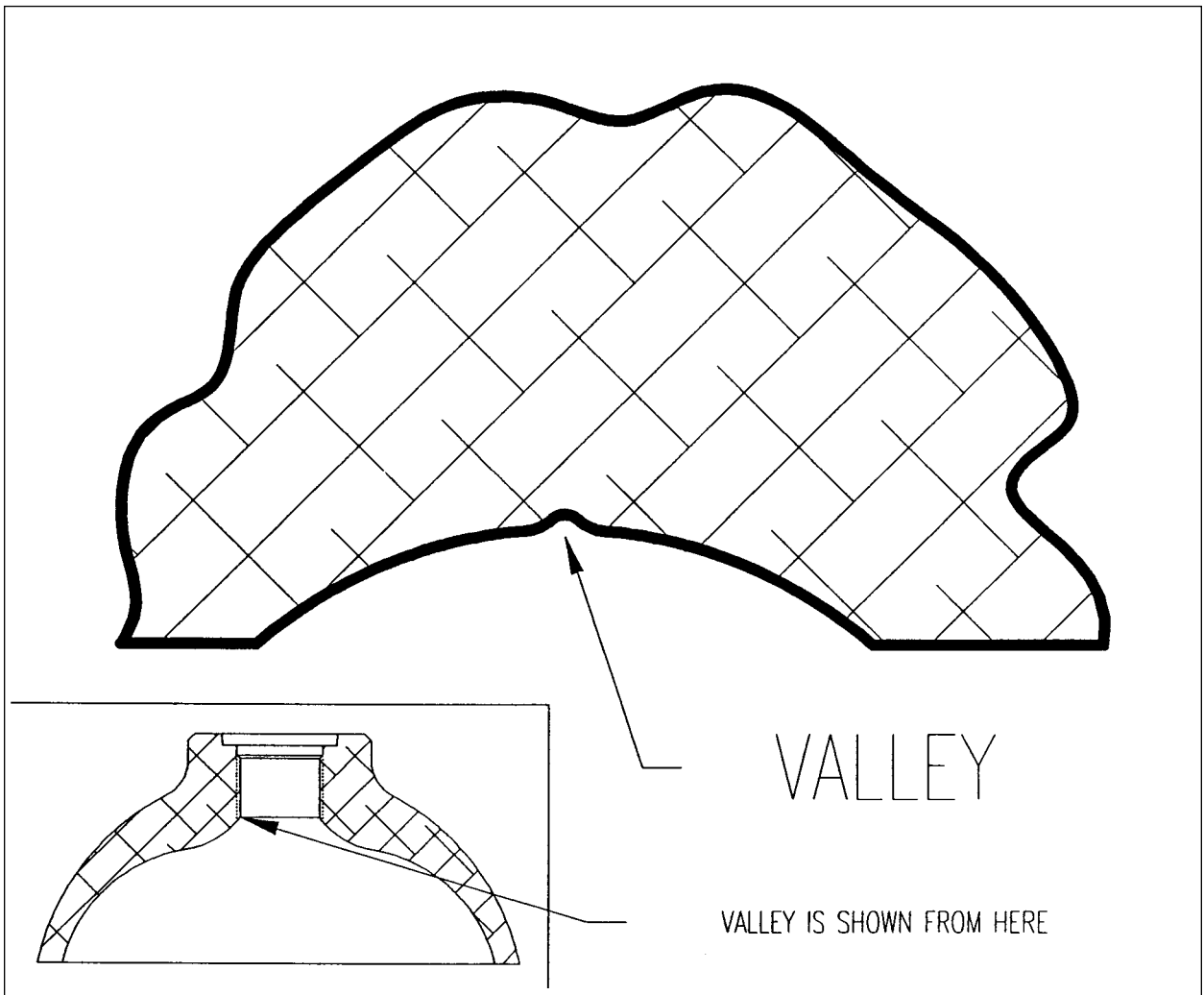

FIGURE 7.

In FIGURE 7, the valley is shown from a cross sectional view of the bottom of the threaded area. The valley has a rounded effect in the metal flow. See PHOTO 16 and 17.

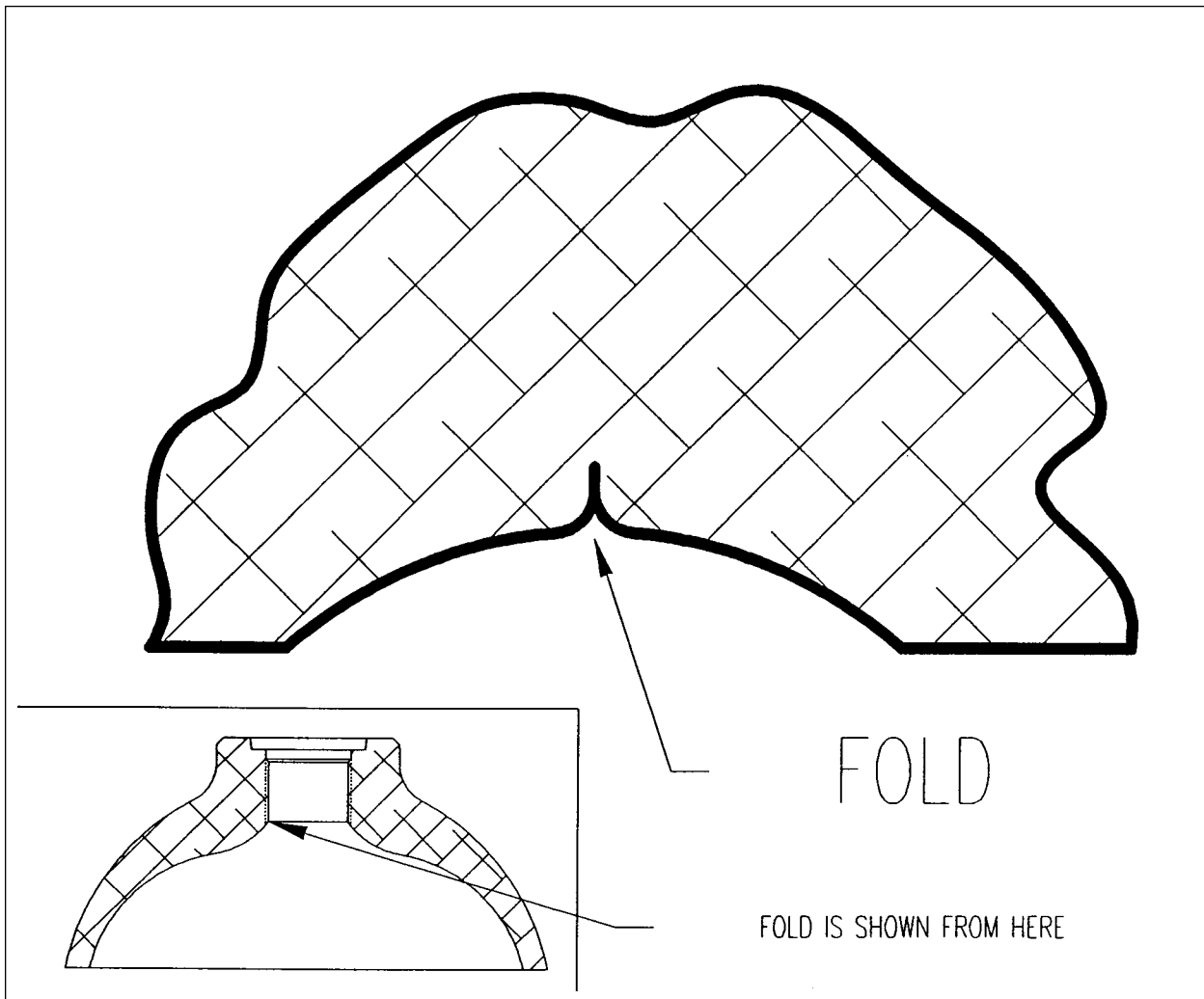

FIGURE 8.

In FIGURE 8, the fold is shown from a cross sectional view of the bottom of the threaded area. The fold has a definite flow back into the shoulder. See PHOTO 14 and 15.

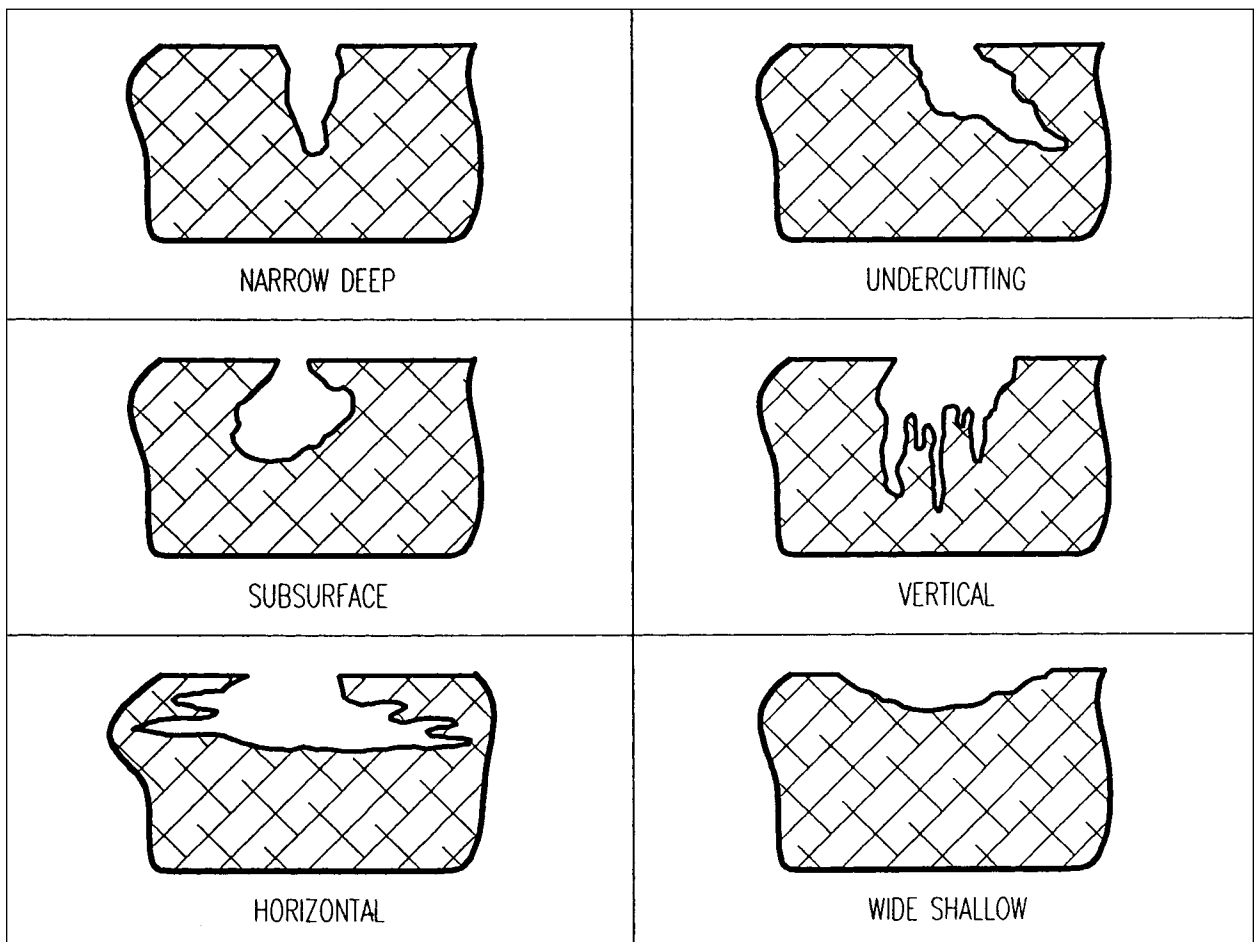

FIGURE 9.

In FIGURE 9, the various shapes of pits are shown from a cross sectional view of the sidewall, base or crown section of the cylinder. The gap section of the pits represents where the sidewall, base or crown metal was, before pitting began. All cross sections are greatly magnified.

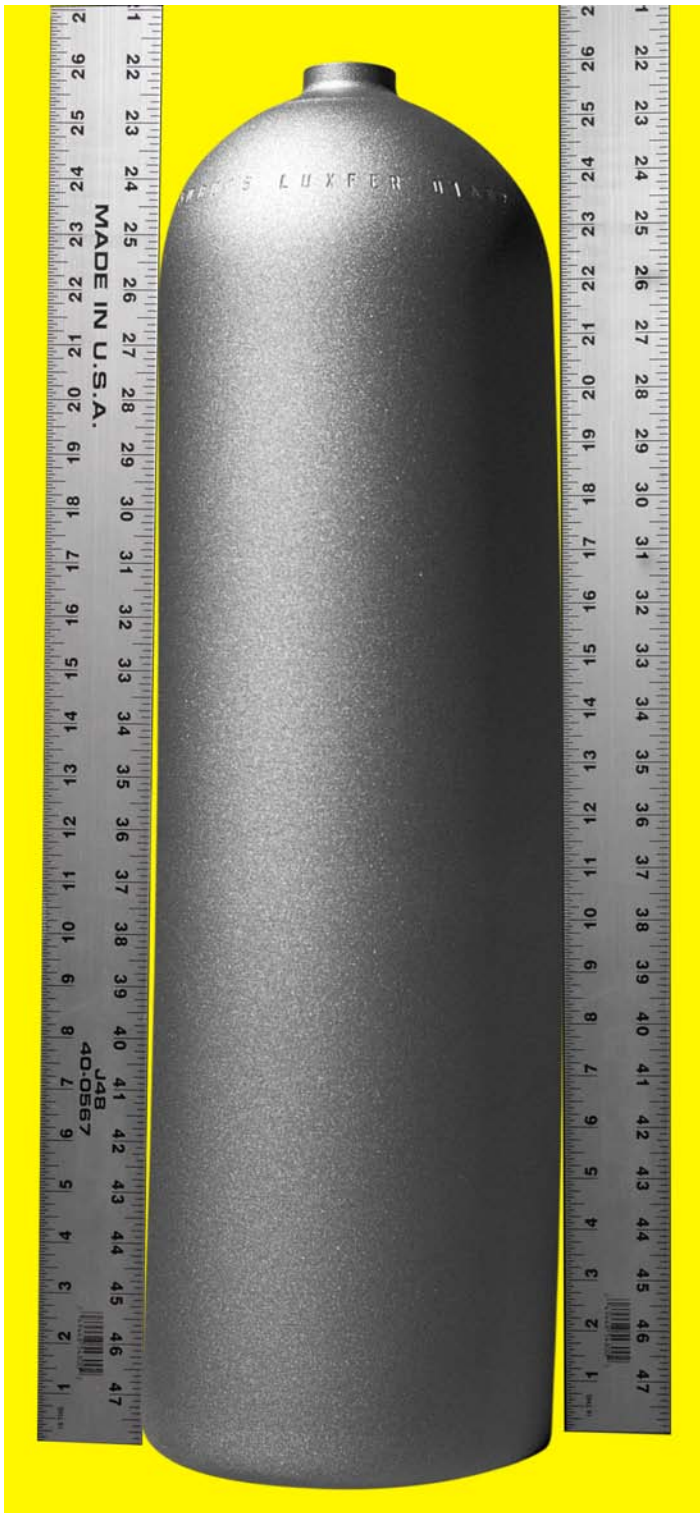

FIGURE 10: Bowed Cylinder

A bow is a slight curve in the sidewall of an aluminum cylinder. A fairly common cosmetic feature, a bow is not dangerous and does not affect cylinder performance. A bow is an occasional by-product of the manufacturing process, not a manufacturing defect. Bows occur most often in taller cylinders, including scuba cylinders with a capacity of 80 cubic feet or more.

A typical bowed cylinder has one convex side curving slightly outward and an opposite concave side (180° degrees away) curving slightly inward. The curves are long and gradual, covering much of the length of the cylinder sidewall. Most bows are barely discernible with the naked eye, but they sometimes become noticeable when you hold a straight edge against the cylinder wall and rotate the cylinder to reveal both the convex and concave sides. More severely bowed cylinders are sometimes called “banana shaped,” and even these cylinders are safe to use.

Infrequently a cylinder will have one straight side and one slightly convex (outward curving) side. Such a condition, called an unparallel sidewall or a plano-convexity, is also a type of bow. It does not affect cylinder performance.

Inspectors should be careful not to misidentify the harmless, slightly convex side of a bowed cylinder as a bulge, which is completely different and a very rare condition (see Figure 11).

A bow is often so subtle that the naked eye has difficulty detecting it. (In the picture above, the bow has been exaggerated somewhat to make it clearly visible.) Using a straight edge will usually reveal convexity and concavity. Bear in mind that the convex (outward curving) side is sometimes more pronounced than the concave side. Do not mistake the convexity of a bow for a bulge! (For more information about bulges, see Figure 11.)



FIGURE 11: Bulged Cylinder

A bulge is an extremely rare, dangerous condition. Bulged cylinders must be immediately condemned and removed from service. Unlike a bow, which is usually slight and sometimes difficult to see, a bulge is generally very pronounced and obvious, even to the naked eye. Bulges occur in cylinders that have been overheated or in cylinders with sidewalls thinned by severe corrosion. There are two basic types of bulges. A long, convex bulge protrudes outward noticeably on one side or around the entire circumference of the cylinder (as in the yellow cylinder shown above on the left); such a bulge occurs when an entire cylinder has been exposed to high heat. A smaller, “goose-egg-shaped” bulge (cylinder at right, above) usually indicates localized overheating, which is the result of “spot annealing.”

If you are uncertain whether a cylinder is bulged, remove it from service and contact Luxfer Customer Service before condemning the cylinder.



PHOTOS

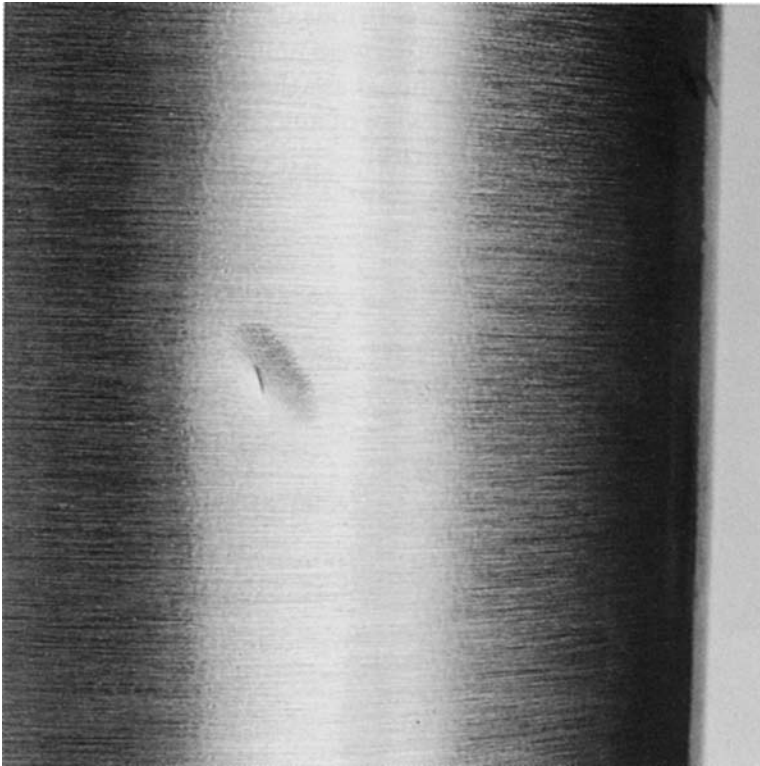

PHOTO 1. Dented cylinder.
This cylinder has a 'brushed finish'
with a clear coating.

PHOTO 2. Gouged cylinder.



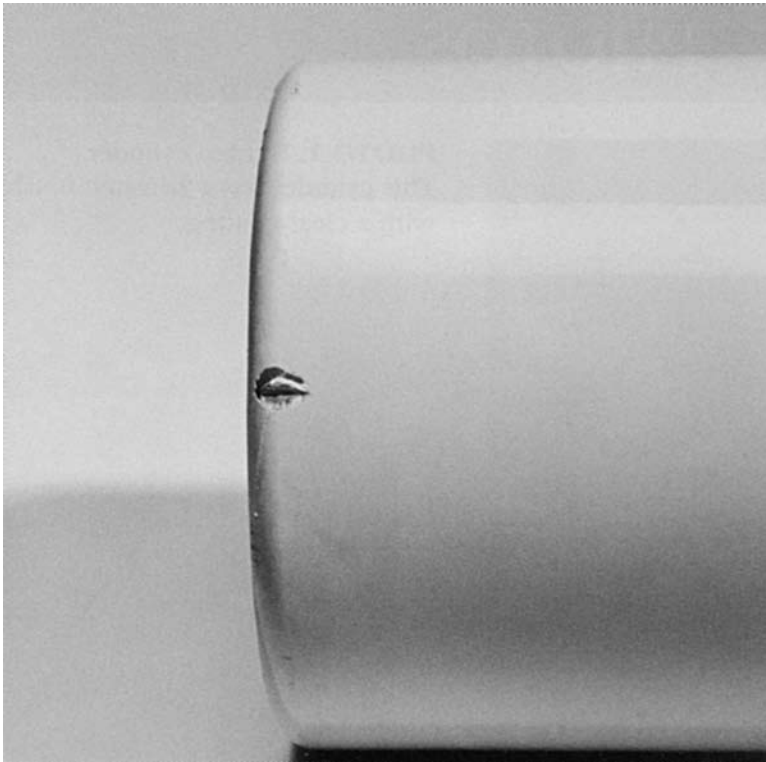

PHOTO 3. Cylinder shows signs of having been in an accident or dropped. May have been struck or fallen. The inspector, seeing an obvious deviation on an otherwise uniform cylinder should ask the owner if he/she is aware of any cause for such a mark.

PHOTO 4. Damaged threads. Notice that, looking down on the threads, this damage is not readily apparent without the use of a dental mirror.

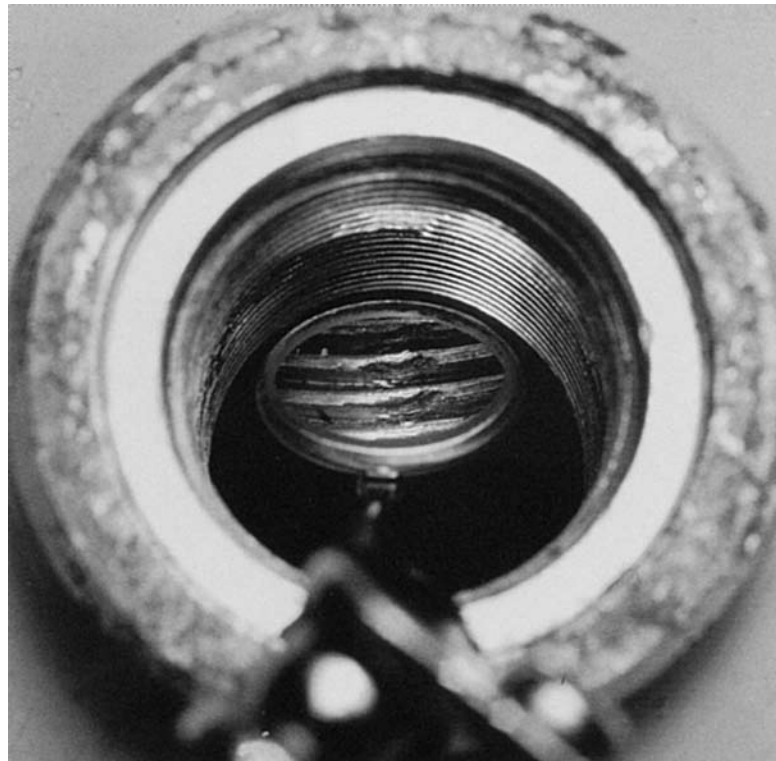
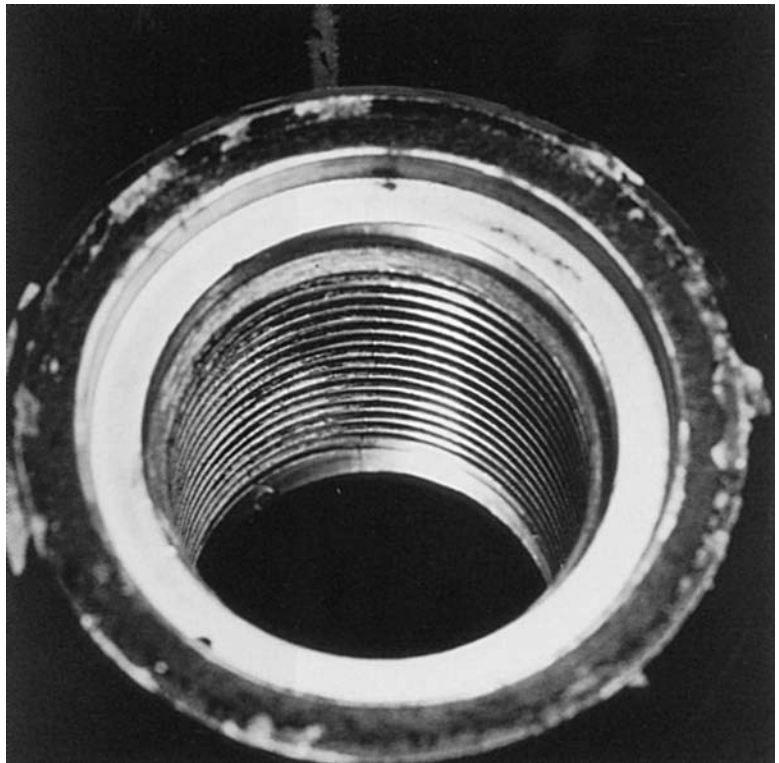



PHOTO 5. Damaged threads. This damage is easily seen with the naked eye, but the thread area is dirty and first needs cleaning (see NOTE 9), before proceeding with the visual inspection of the thread area.

PHOTO 6. Cracked thread. This is a very subtle, hair-line crack through most of the threads. Hard to see with the naked eye. It is usual for the crack to be jagged, rather than straight.



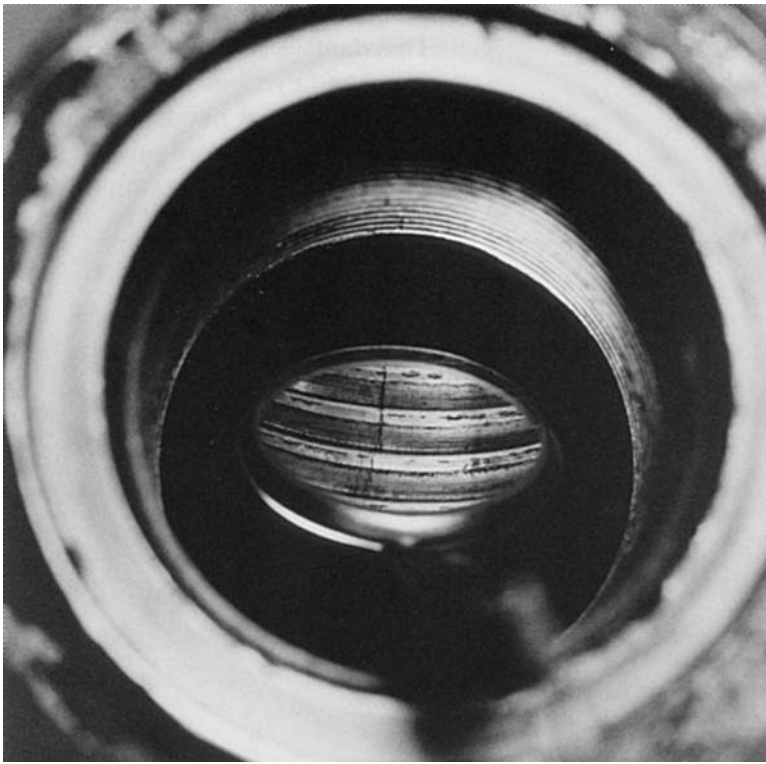

PHOTO 7. A crack in the threads found by the use of a dental mirror.

PHOTO 8. A crack in dirty threads. Threads need to be cleaned before the visual inspection begins. (See NOTE 9.)

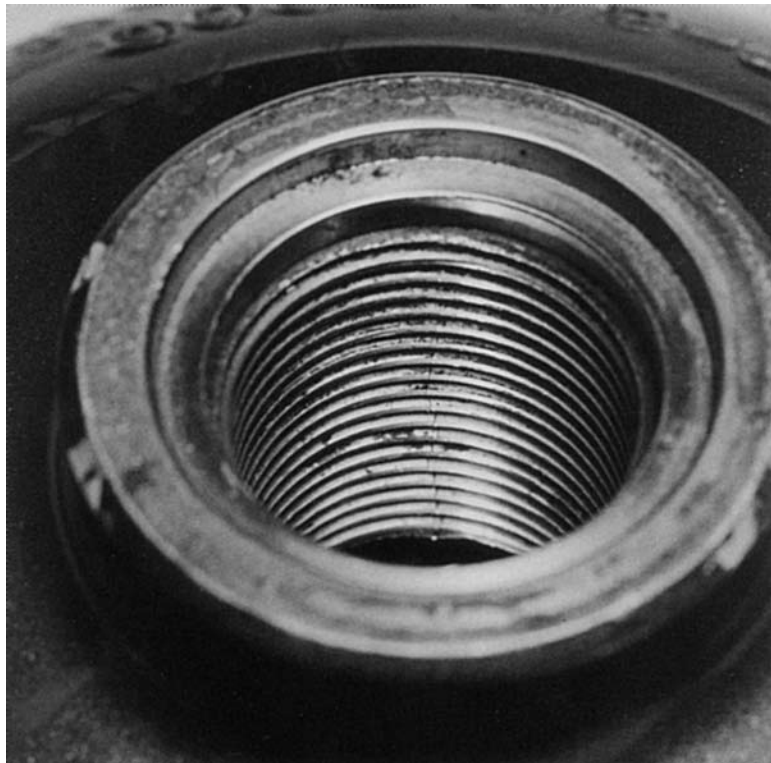
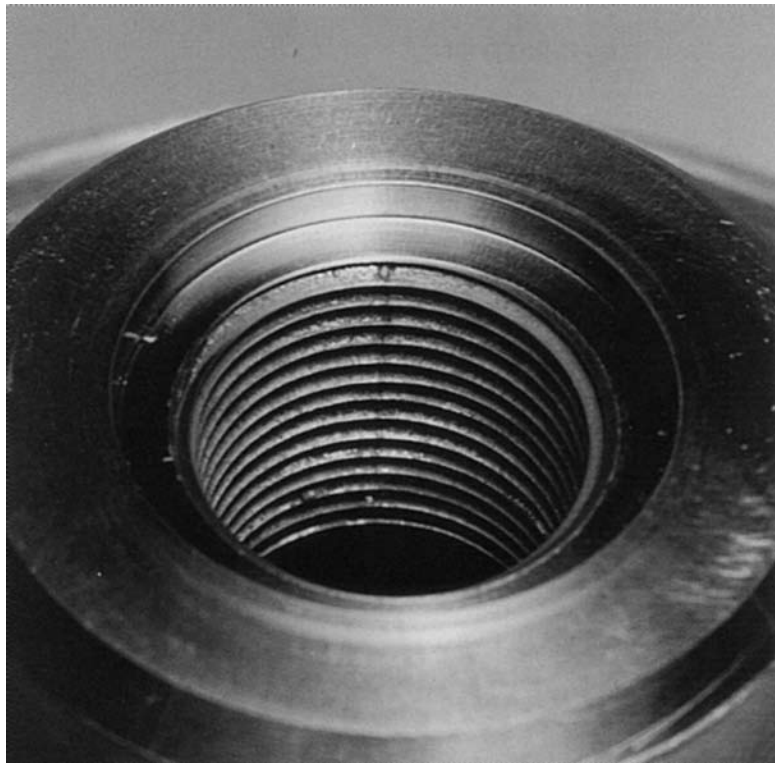



PHOTO 9. A crack easily seen with the naked eye, near the top or O-ring gland. A quick cleaning should be done, enough to verify that it is a crack.

PHOTO 10. Example of a tool stop mark. Tool stop marks may appear to be like a crack, but the inspector will note that the tool stop is straight, through most of the threads, and is more like a wide smudge and contains no depth or opening. Careful inspection is important. Cracked cylinders are to be condemned; cylinders with tool stop marks that pass all other inspection criteria should be returned to service.



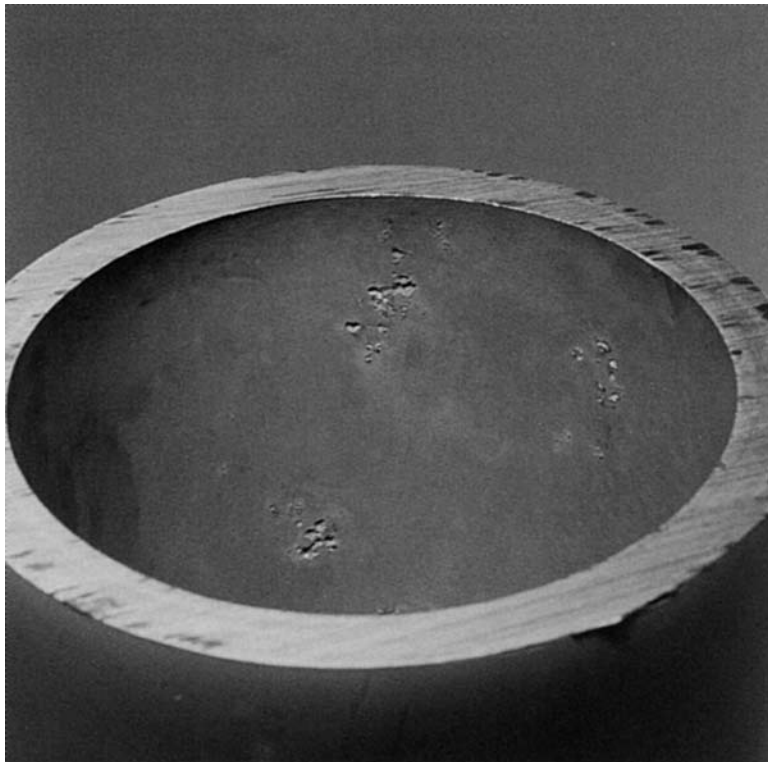
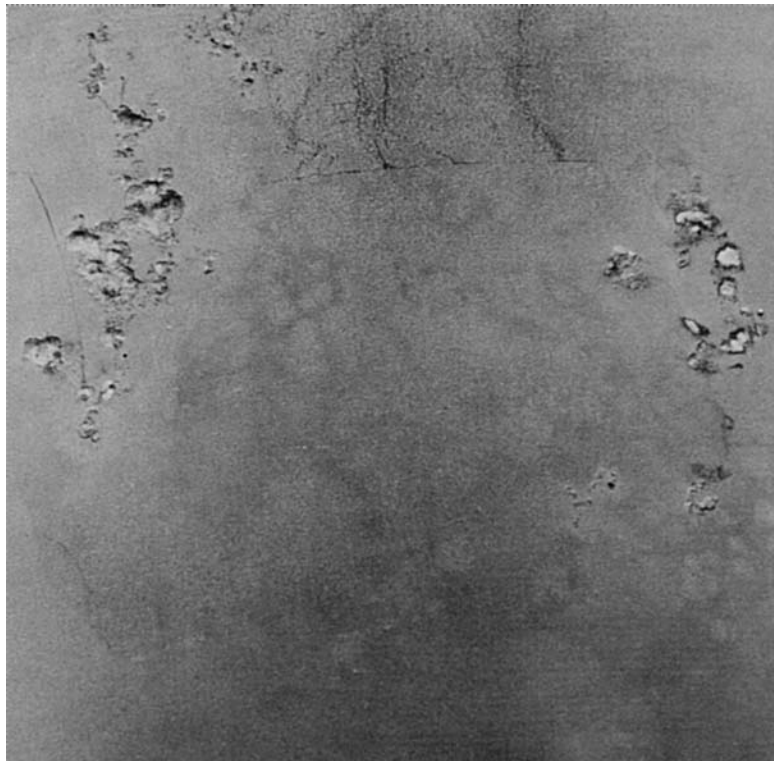

PHOTO 11. Pit corrosion in the cylinder sidewall distant view.

PHOTO 12. Close up of pit corrosion from PHOTO 11.



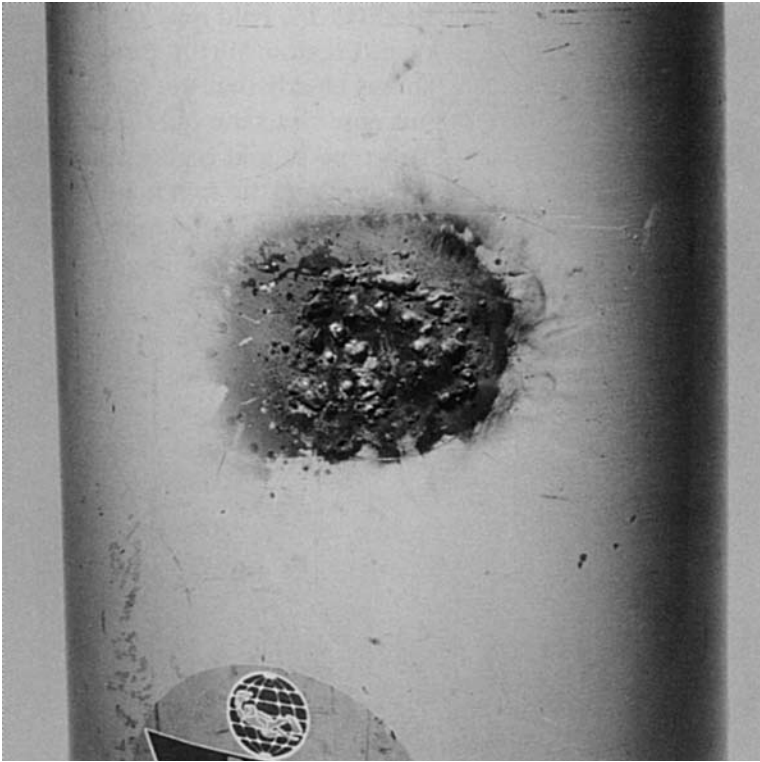

PHOTO 14. Appearance of fire or welding damage done to a cylinder.

PHOTO 14. Inside view (looking from the inside towards the crown) of a fold near the threads.

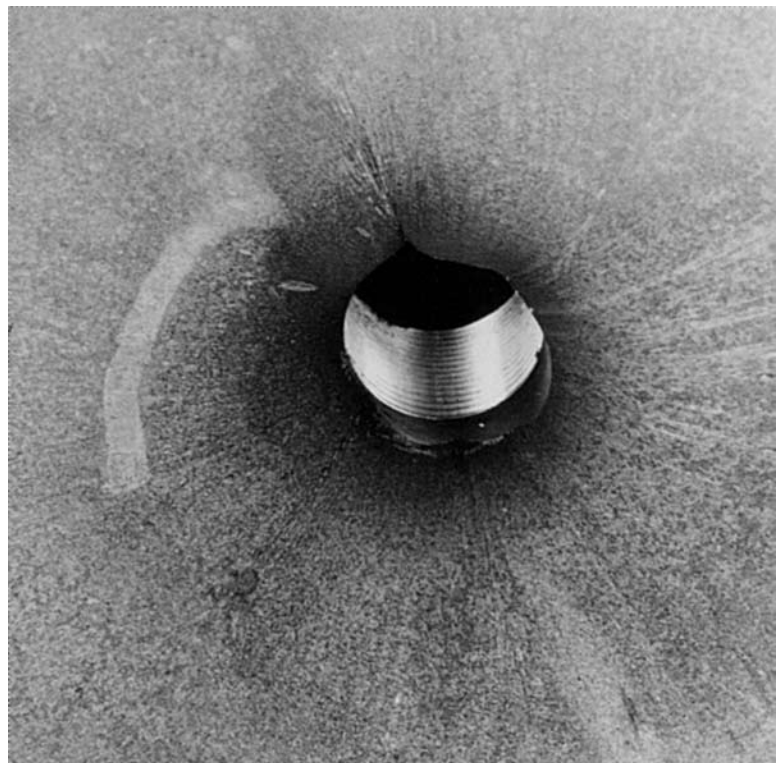
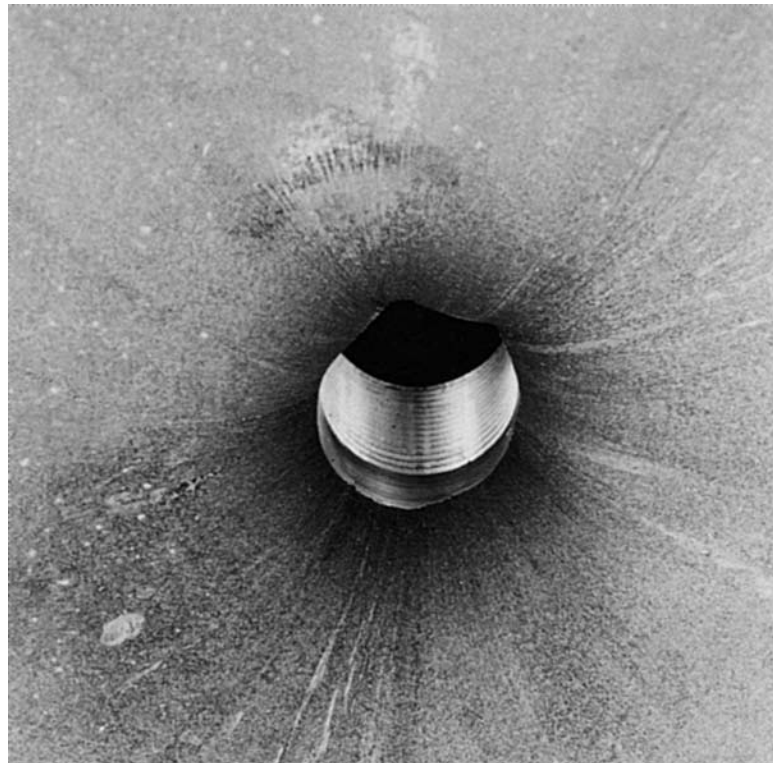



PHOTO 15. Fold near the thread region. Mirror view shows clearly that the fold does not enter into the full-thread area. This type of fold is acceptable if the depth of the fold is estimated to be less than 0.060 inch (1.53 mm).

PHOTO 16. Inside view (looking from the inside towards the crown) of a valley.



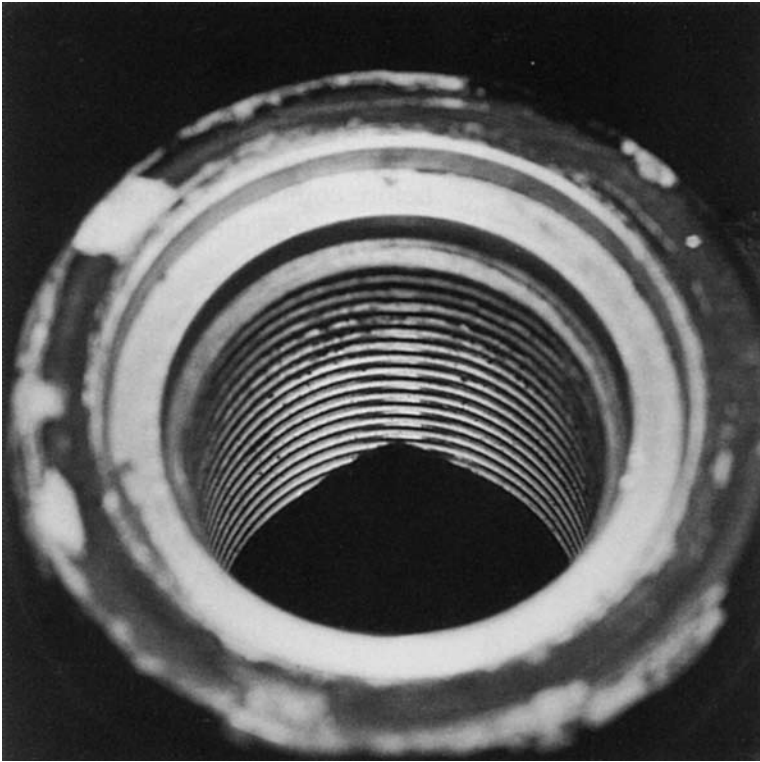
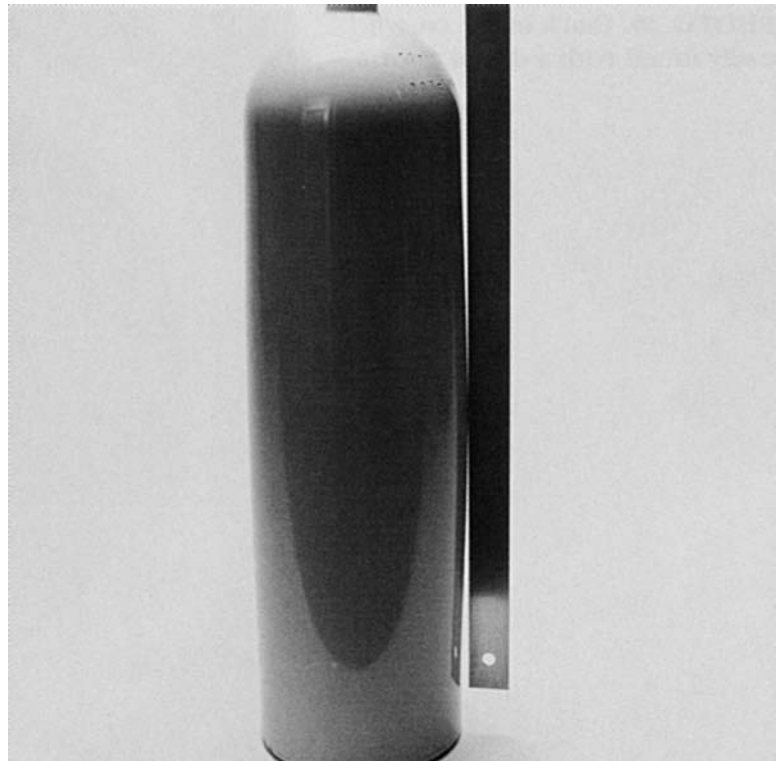

PHOTO 17. The appearance of a valley, looking into the cylinder at an angle.

PHOTO 18. Cylinder with bow or “banana.” The bow shows easily with a straight edge placed along the length of the cylinder (see FIGURE 11 of a bow ‘from the other side’).



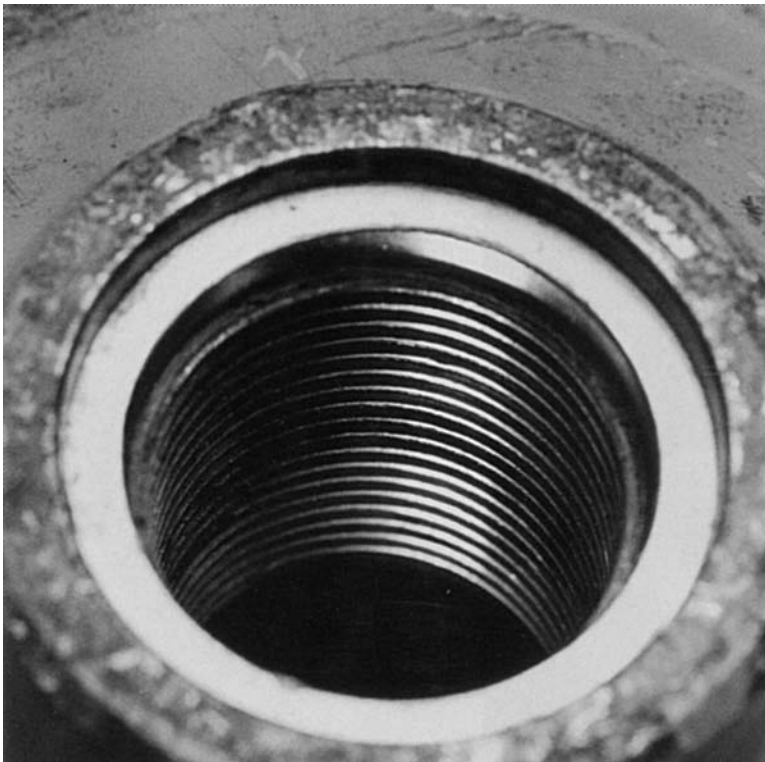

PHOTO 19. Dirty and worn threads. The threads at the bottom are worn and not as 'sharp' as the threads near the top. The threads need to be cleaned before counting the good threads (starting from the top).

PHOTO 20. Crack in the crown, easily found with a dental mirror.

